

## Farol clásico

Código	Color	Descripción	W	V	Hz	Base	Piezas
9400420	●	Farol de pared clásico	100	127	60	E-26	1
9400421	○	Farol de pared clásico	100	127	60	E-26	1



## Características

- Material: aluminio inyectado.
- Terminado: pintura color negro o blanco.
- Pantalla: cristal transparente.

## Farol colonial

Código	Color	Descripción	W	V	Hz	Base	Piezas
9400425	●	Farol de pared colonial	100	127	60	E-26	1
9400426	○	Farol de pared colonial	100	127	60	E-26	1

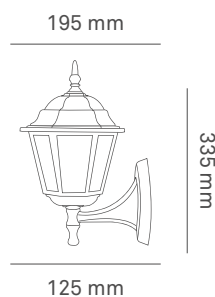

## Características

- Material: aluminio inyectado.
- Terminado: pintura color negro o blanco.
- Pantalla: cristal transparente.

## Luminario cuadrado de empotrar VR de LED con 2 lámparas PLC blanco

Código	W	V	Hz	K	Base	Ángulo	lm	Piezas
A1F-2L9S41-F-B4/111	22	120-277	50/60	4 100	G24q3	75°-45°	2 300	1

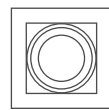
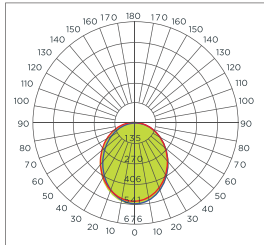

240 mm

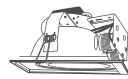

152 mm

240 mm



### Carcasa

Código	Cuerpo	Terminado	Aplicaciones	Tipo de lámpara	Lámpara incluida	Base	Piezas
A1F-0S9S0-G-B4/01	Aluminio	Blanco	Empotrar en techo	PLC	No	G24q3	1

## Luminario cuadrado de empotrar VC de LED con 2 lámparas PLC blanco

Código	W	V	Hz	K	Base	Ángulo	lm	Piezas
A1F-2L9S41-F-B3/111	22	120-277	50/60	4 100	G24q3	75°	2 300	1

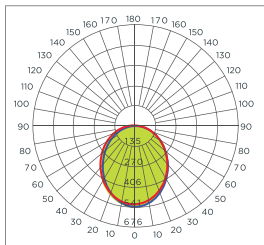

230 mm

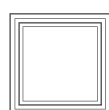

230 mm

230 mm



### Carcasa

Código	Cuerpo	Terminado	Aplicaciones	Tipo de lámpara	Lámpara incluida	Base	Piezas
A1F-0S9S0-G-B3/01	Aluminio	Blanco	Empotrar en techo	PLC	No	G24q3	1

## Luminario cuadrado de empotrar CU de LED con 2 lámparas PLC blanco

Código	W	V	Hz	K	Base	Ángulo	lm	Piezas
A1F-2L9S41-F-B3/112	22	120-277	50/60	4 100	G24q3	75°	2 300	1

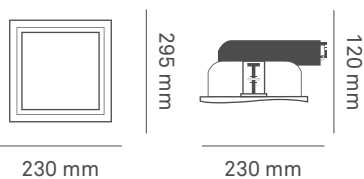
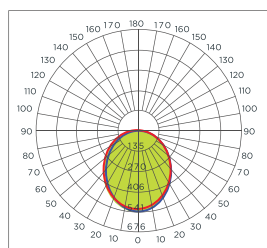
**NOM**

**LED**

### Carcasa

Código	Cuerpo	Terminado	Aplicaciones	Tipo de lámpara	Lámpara incluida	Base	Piezas
A1F-0S9S0-G-B3/02	Aluminio	Blanco	Empotrar en techo	PLC	No	G24q3	1

## Luminario cuadrado de empotrar CR de LED con 2 lámparas PLC blanco

Código	W	V	Hz	K	Base	Ángulo	lm	Piezas
A1F-2L9S41-F-B3/113	22	120-277	50/60	4 100	G24q3	60°	2 300	1

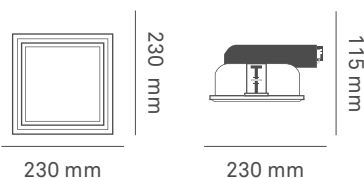
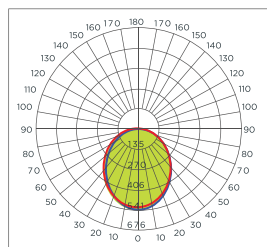
**NOM**

**LED**

### Carcasa

Código	Cuerpo	Terminado	Aplicaciones	Tipo de lámpara	Lámpara incluida	Base	Piezas
A1F-0S9S0-G-B3/03	Aluminio	Blanco	Empotrar en techo	PLC	No	G24q3	1

## Luminario cuadrado de empotrar RA de LED con 2 lámparas PLC blanco

Código	W	V	Hz	K	Base	Ángulo	lm	Piezas
A1F-2L9S41-F-B5/111	22	120-277	50/60	4 100	G24q3	60°	2 300	1

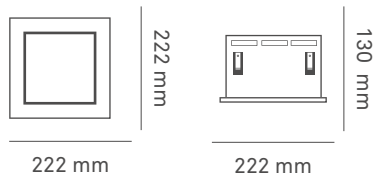
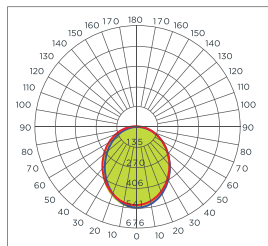

### Carcasa

Código	Cuerpo	Terminado	Aplicaciones	Tipo de lámpara	Lámpara incluida	Base	Piezas
A1F-0S9S0-G-B5/01	Aluminio	Blanco	Empotrar en techo	PLC	No	G24q3	1

## Luminario cuadrado de empotrar LI de LED con 2 lámparas PLC Blanco

Código	W	V	Hz	K	Base	Ángulo	lm	Piezas
A1F-2L9S41-F-B3/110	22	120-277	60	4 100	G24q3	75°	2 300	1

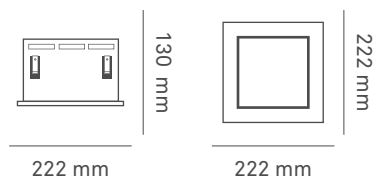
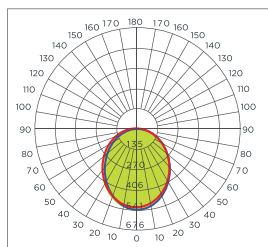

### Carcasa

Código	Cuerpo	Terminado	Aplicaciones	Tipo de lámpara	Lámpara incluida	Base	Piezas
A1F-0S9S0-G-B3/00	Aluminio	Blanco	Empotrar en techo	PLC	No	G24q3	1

## Luminario cuadrado de sobreponer de LED con 2 lámparas PLC blanco

Código	W	V	Hz	K	Base	Ángulo	lm	Piezas
A4F-2L9S41-F-B3/110	22	120-277	50/60	4 100	G24q3	75°-65°	2 300	1

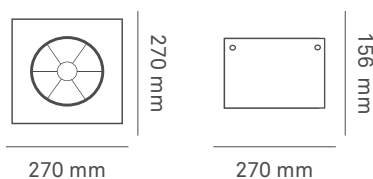
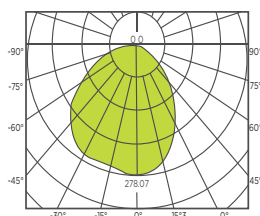

### Carcasa

Código	Cuerpo	Terminado	Aplicaciones	Tipo de lámpara	Lámpara incluida	Base	Piezas
A4F-0S10S0-G-B3/00	Aluminio	Blanco	Sobreponer en techo	PLC	No	G24q3	1

## Luminario circular de empotrar VE de LED con 2 lámparas PLC blanco

Código	W	V	Hz	K	Base	Ángulo	lm	Piezas
A1F-2L9S27-F-B1/110	22	120-277	50/60	4 100	G24q3	75°	2 300	1

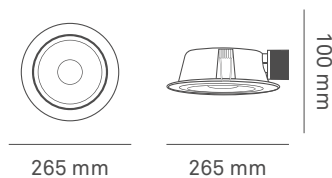
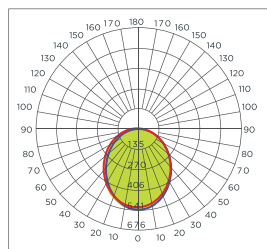

### Carcasa

Código	Cuerpo	Terminado	Aplicaciones	Tipo de lámpara	Lámpara incluida	Base	Piezas
A1F-0S9S0-G-B1/00	Aluminio	Satinado	Empotrar en techo	PLC	No	G24q3	1

### Luminario circular de empotrar LV de LED con 2 lámparas PLC blanco

Código	W	V	Hz	K	Base	Ángulo	lm	Piezas
A1F-2L9S27-F-B1/111	22	120-277	50/60	4 100	G24q3	75°	2 300	1

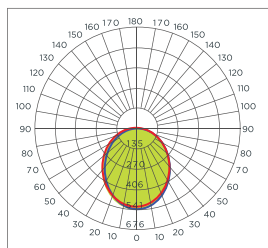

195 mm



195 mm

128 mm



#### Carcasa

Código	Cuerpo	Terminado	Aplicaciones	Tipo de lámpara	Lámpara incluida	Base	Piezas
A1F-0S9S0-G-B1/01	Aluminio	Blanco	Empotrar en techo	PLC	No	G24q3	1

### Luminario circular de empotrar VL de LED con 2 lámparas PLC blanco

Código	W	V	Hz	K	Base	Ángulo	lm	Piezas
A1F-2L9S27-F-B1/112	22	120-277	50/60	4 100	G24q3	75°	2 300	1

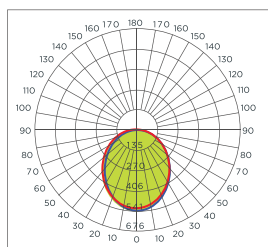

270 mm

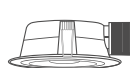

270 mm

100 mm



#### Carcasa

Código	Cuerpo	Terminado	Aplicaciones	Tipo de lámpara	Lámpara incluida	Base	Piezas
A1F-0S9S0-G-B1/02	Aluminio	Blanco	Empotrar en techo	PLC	No	G24q3	1

## Luminario circular de sobreponer de LED con 2 lámparas PLC blanco

Código	W	V	Hz	K	Base	Ángulo	lm	Piezas
A4F-2L10S41-F-B1/110	22	120-277	50/60	4 100	G24q3	75°	2 300	1

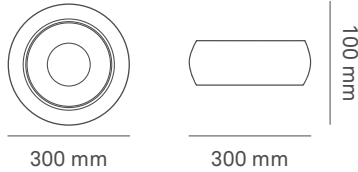
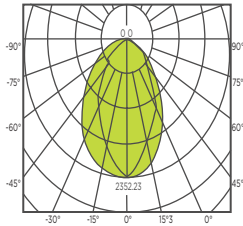

### Carcasa

Código	Cuerpo	Terminado	Aplicaciones	Tipo de lámpara	Lámpara incluida	Base	Piezas
A4F-0S10S0-G-B1/00	Aluminio	Blanco	Sobreponer en techo	PLC	No	G24q3	1

## Luminario cuadrado de empotrar de LED blanco

Código	W	V	Hz	K	lm	Vida	Piezas
						(horas)	
A1F-1L8S27-G-B2/200	20	120-240	60	4 100	1 440	35 000	1

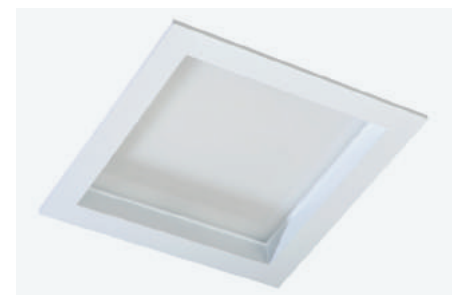
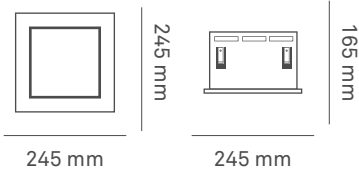
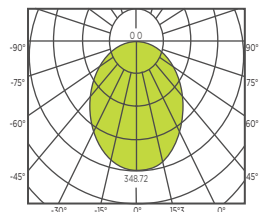

### Luminario cuadrado de empotrar de LED dirigible blanco

Código	W	V	Hz	K	lm	Vida (horas)	Piezas
A1D-1L8S27-C-B3/60	6	120-240	60	2 700	480	35 000	1

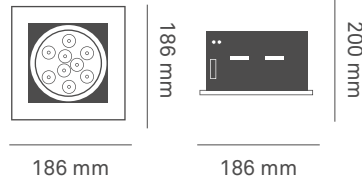
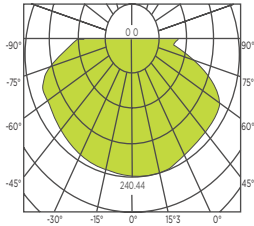

### Luminario cuadrado de empotrar de LED con difusor tipo pirámide de acrílico blanco

Código	W	V	Hz	K	lm	Vida (horas)	Piezas
AFL104A	20	110-240	60	4 200	1 500	35 000	1

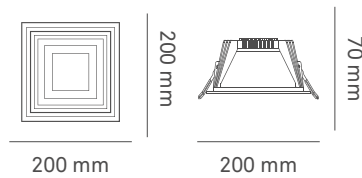
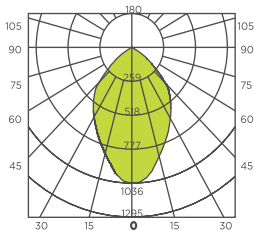



## Luminario cuadrado de empotrar de LED 1 salida dirigible con reflector especular gris

Código	W	V	Hz	K	lm	Vida (horas)	Piezas
AF001ABL	25	120-240	60	4 200	2 120	35 000	1

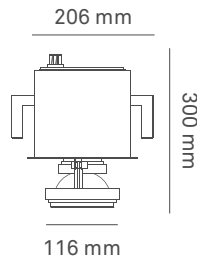
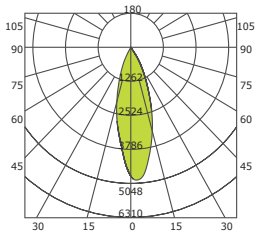

## Luminario cuadrado de empotrar de LED 2 salidas dirigible con reflector especular gris

Código	W	V	Hz	K	lm	Vida (horas)	Piezas
AF002ABL	2x25	110-240	60	4 200	4 180	35 000	1

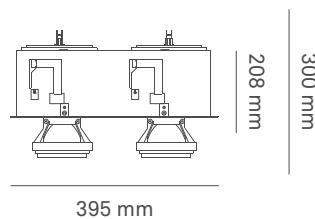
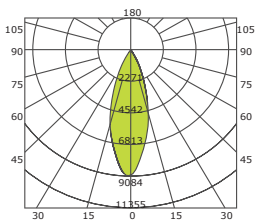

### Luminario cuadrado de empotrar de LED 1 salida dirigida con reflector circular de acrílico blanco

Código	W	V	Hz	K	lm	Vida (horas)	Piezas
AFL100	10	110-240	60	3 000	870	35 000	1

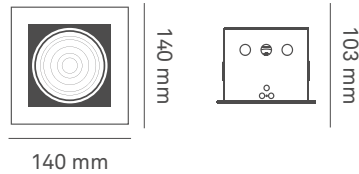
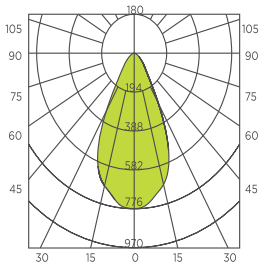

### Luminario cuadrado de empotrar de LED 2 salidas dirigida con reflector circular de acrílico blanco

Código	W	V	Hz	K	lm	Vida (horas)	Piezas
AFL100-2	2x10	110-240	60	3 000	1 750	35 000	1

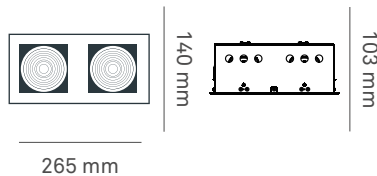
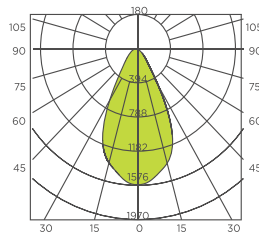

## Luminario cuadrado de empotrar de LED 3 salidas dirigible de acrílico con reflector circular blanco

Código	W	V	Hz	K	lm	Vida (horas)	Piezas
AFL100-3	3x10	110-240	60	3 000	2 450	35 000	1

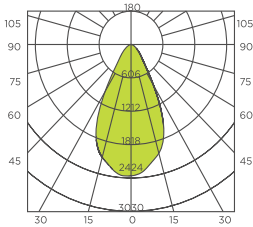

265 mm

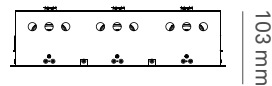

265 mm



## Luminario cuadrado de empotrar de LED 4 salidas dirigible de acrílico con reflector circular blanco

Código	W	V	Hz	K	lm	Vida (horas)	Piezas
AFL100-4	4x10	110v240	60	3 000	3 280	35 000	1

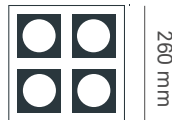
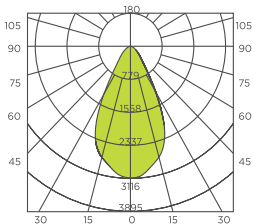

260 mm



260 mm



### Luminario cuadrado de empotrar de LED 1 salida dirigida especular con reflector circular blanco

Código	W	V	Hz	K	lm	Vida (horas)	Piezas
AFL72A	6.5	110-240	60	3 000	525	35 000	1

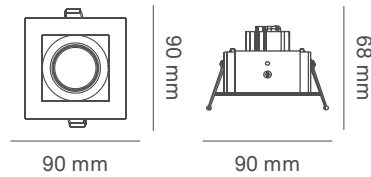
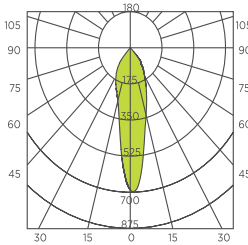

### Luminario cuadrado de empotrar de LED 2 salidas dirigida especular con reflector circular blanco

Código	W	V	Hz	K	lm	Vida (horas)	Piezas
AFL72A-2	2x6.5	110-240	60	3 000	1 030	35 000	1

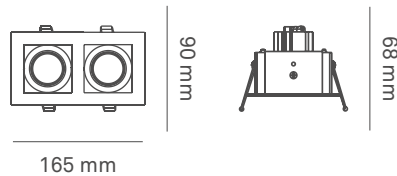
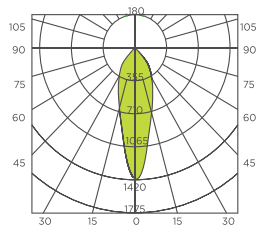

### Luminario cuadrado de empotrar de LED 3 salidas dirigible especular con reflector circular blanco

Código	W	V	Hz	K	lm	Vida (horas)	Piezas
AFL72A-3	3x6.5	110-240	60	3 000	1 550	35 000	1

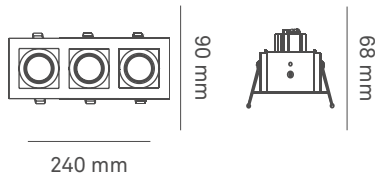
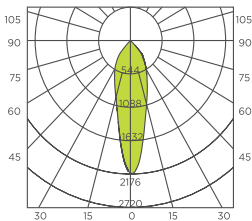

### Luminario cuadrado de empotrar de LED 4 salidas dirigible especular con reflector circular blanco

Código	W	V	Hz	K	lm	Vida (horas)	Piezas
AFL72A-4	4x6.5	110-240	60	3 000	2 070	35 000	1

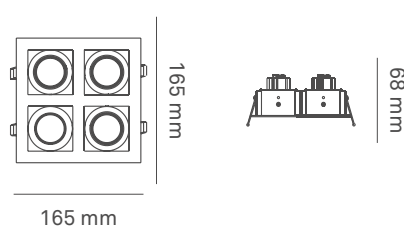
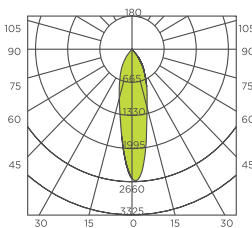

### Luminario cuadrado de empotrar de LED 1 salida fijo especular con reflector cuadrado blanco

Código	W	V	Hz	K	lm	Vida (horas)	Piezas
AFL72B	10	110-240	60	3 000	840	35 000	1

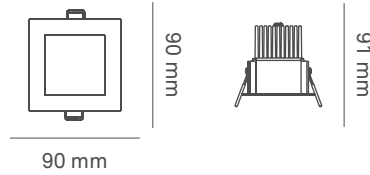
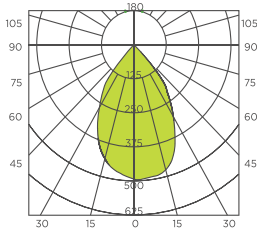
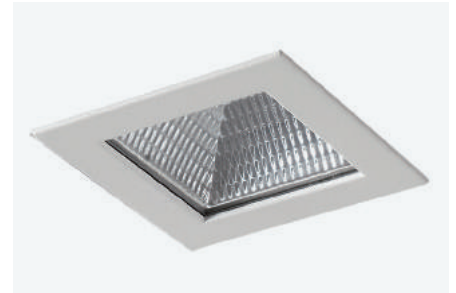

### Luminario cuadrado de empotrar de LED 2 salidas fijo especular con reflector cuadrado blanco

Código	W	V	Hz	K	lm	Vida (horas)	Piezas
AFL72B-2	2x10	220-240	60	3 000	1 650	35 000	1

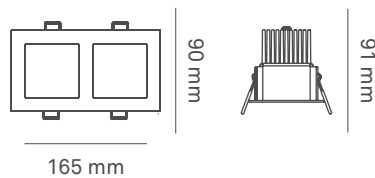
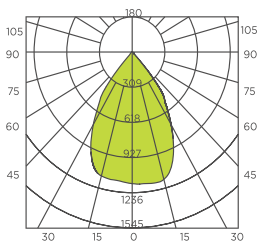

## Luminario cuadrado de empotrar de LED 3 salidas fijo especular con reflector cuadrado blanco

Código	W	V	Hz	K	lm	Vida (horas)	Piezas
AFL72B-3	3x10	110-240	60	3 000	2 480	35 000	1

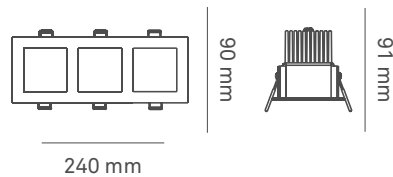
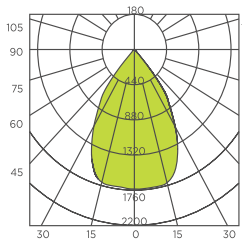

## Luminario cuadrado de empotrar de LED 4 salidas fijo especular con reflector cuadrado blanco

Código	W	V	Hz	K	lm	Vida (horas)	Piezas
AFL72B-4	4x10	110-240	60	4 200	3 280	35 000	1

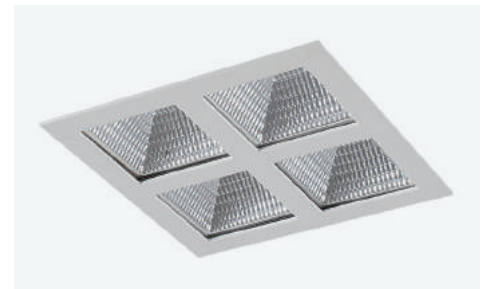
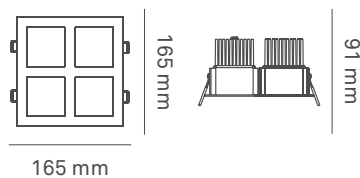
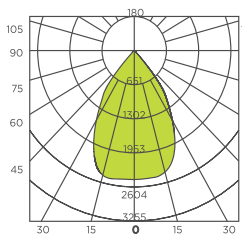

## Luminario cuadrado de empotrar de LED con difusor cuadrado de acrílico blanco

Código	W	V	Hz	K	lm	Vida (horas)	Piezas
AF8031L	20	110-240	60	4 200	1 698	35 000	1

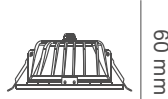
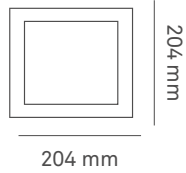
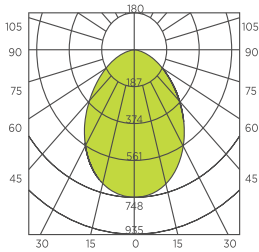

## Luminario cuadrado de empotrar de LED con marco de cristal blanco

Código	W	V	Hz	K	lm	Vida (horas)	Piezas
AFL106A	12	110-240	60	3 000	810	35 000	1

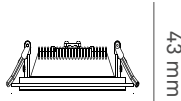
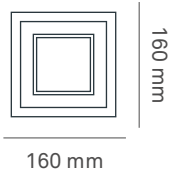
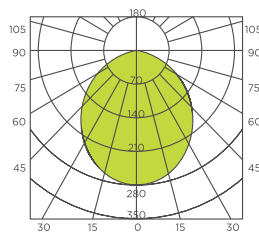



## Luminario downlight de LED

Código	W	V	Hz	K	Dimensiones	lm	Vida	Piezas
					AxB (mm)			
9403150	9	100-240	60	3 000	82x43	800	30 000	1
9403165	12	100-240	60	3 000	125x62	1 100	30 000	1
9403170	18	100-240	60	4 000	190x84	1 400	30 000	1
9403175	23	100-240	60	4 000	230x81	1 600	30 000	1
9403180	36	100-240	60	4 000	230x81	3 200	30 000	1

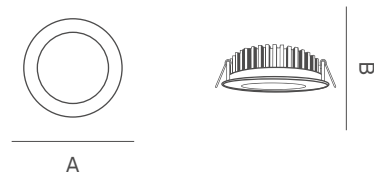

## Luminario downlight de LED con color de temperatura ajustable

Código	W	V	Hz	Dimensiones	lm	Vida	Piezas
				AxB (mm)			
9403162	10	100-277	60	110x37	800	30 000	1
9403177	25	100-277	60	230x82	2 000	30 000	1

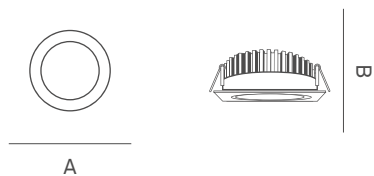

### Luminario downlight dirigible de LED

Código	W	V	Hz	K	lm	Vida (horas)	Piezas
9403155	9	100-240	60	3 000	800	30 000	1

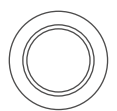
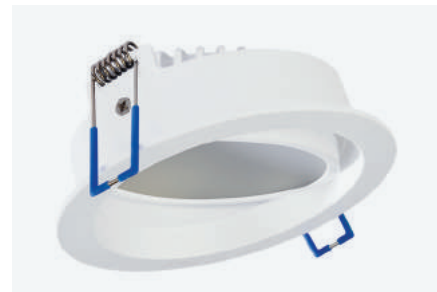

110 mm

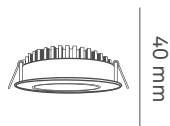

40 mm



### Luminario circular de empotrar de LED fijo especular blanco

Código	W	V	Hz	K	lm	Vida (horas)	Piezas
A1F-1L8S27-G-B1/5.40	5.4	120-240	60	2 700	400	35 000	1

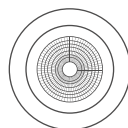
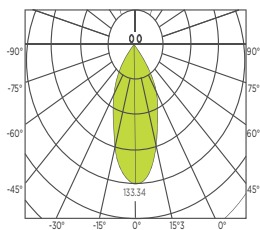

118 mm



90 mm



## Luminario circular de empotrar de LED fijo especular blanco

Código	W	V	Hz	K	lm	Vida (horas)	Piezas
A1F-1L8S27-G-B2/5.40	5.4	120-240	60	2 700	410	35 000	1

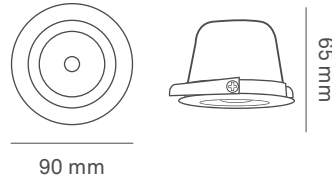
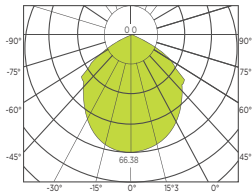

## Luminario circular de empotrar de LED con pantalla de acrílico blanco

Código	W	V	Hz	K	lm	Vida (horas)	Piezas
AF3018YL	10	110-240	60	3 000	550	35 000	1
AF8018YL	20	110-240	60	4 200	1 180	35 000	1



AF3018YL

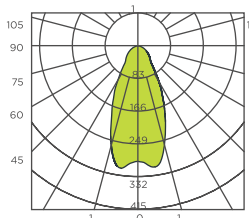

AF8018YL

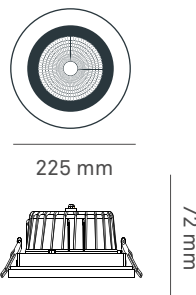
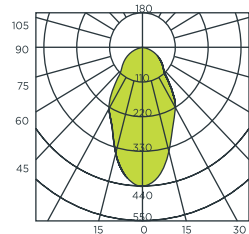

### Luminario circular de empotrar de LED con reflector especular blanco

Código	W	V	Hz	K	lm	Vida (horas)	Piezas
AF5026LA	10	110-240	60	3 000	740	35 000	1

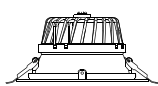
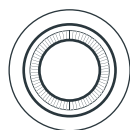
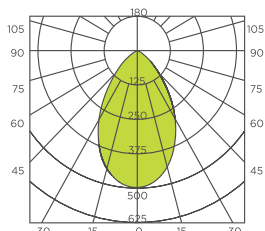

65 mm

180 mm



### Luminario circular de empotrar de LED con reflector cónico especular blanco

Código	W	V	Hz	Dimensiones (mm)	K	lm	Vida (horas)	Piezas
AFL62A	10	110-240	60	131x70	3 000	830	35 000	1
AFL62B	15	120-240	60	162x74	4 200	1 140	35 000	1
AFL62C	20	110-240	60	190x80	4 200	1 605	35 000	1

AFL62A

AFL62B

AFL62C

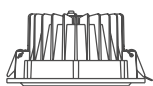
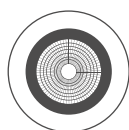
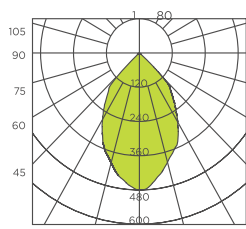
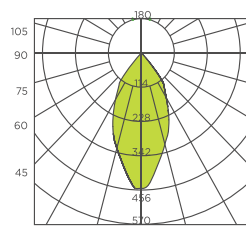
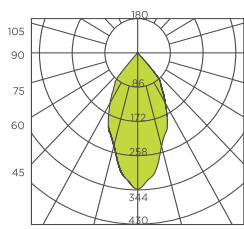

70

A



### Luminario circular de empotrar de LED fijo de aluminio

Código	W	V	Hz	K	lm	Vida (horas)	Piezas
A1F-1L8S27-G-A1/2.50	2.5	120-240	60	2 700	200	35 000	1

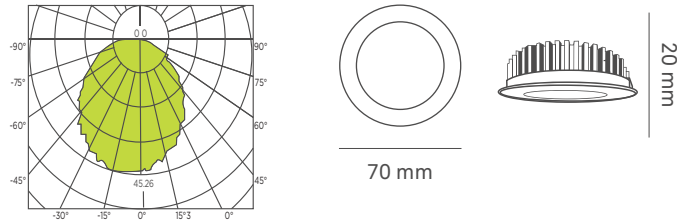

### Luminario circular de empotrar de LED con difusor de acrílico blanco

Código	W	V	Hz	K	lm	Vida (horas)	Piezas
AF2040L	6	110-240	60	3 000	418	35 000	1

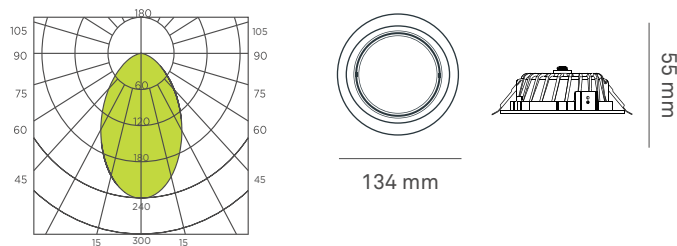

### Luminario circular de empotrar de LED con difusor de acrílico blanco

Código	W	V	Hz	K	lm	Vida (horas)	Piezas
AFL77	45	110-240	60	4 200	3 670	35 000	1

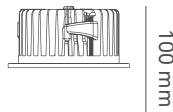
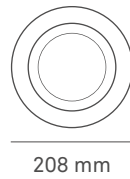
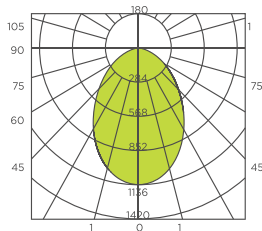

### Luminario circular de empotrar de LED con difusor de acrílico blanco

Código	W	V	Hz	K	lm	Vida (horas)	Piezas
AFL88B	10	110-240	60	3 000	650	35 000	1

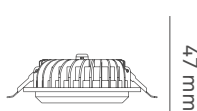
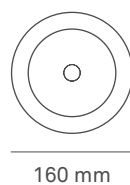
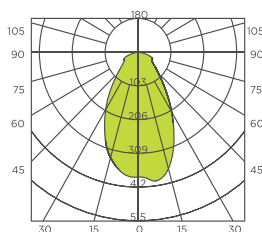

## Luminario circular de empotrar de LED con marco de cristal blanco

Código	W	V	Hz	K	lm	Vida (horas)	Piezas
AFL105A	12	110-240	60	3 000	800	35 000	1

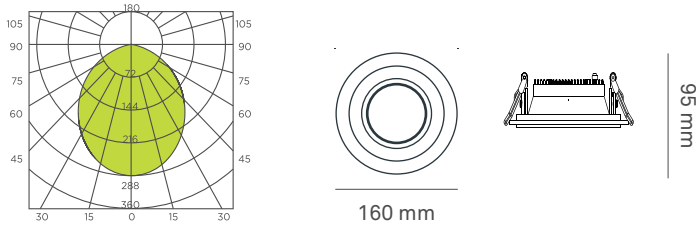
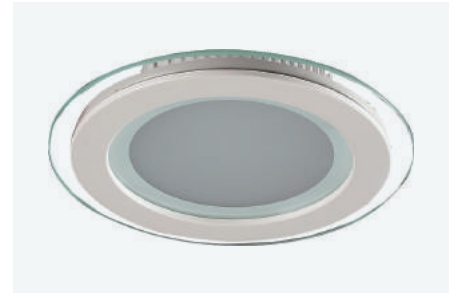

## Luminario circular de empotrar de LED dirigible con reflector espejador blanco

Código	W	V	Hz	K	lm	Vida (horas)	Piezas
AFL90	6.5	110-240	60	3 000	550	35 000	1

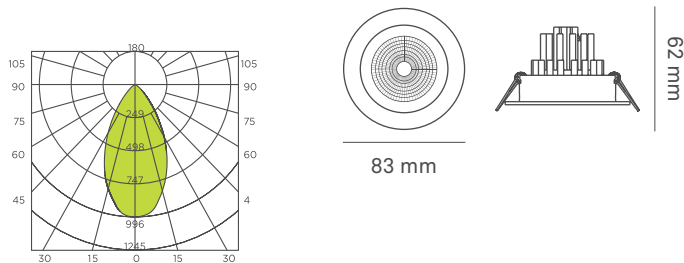

### Luminario circular de empotrar de LED dirigible con reflector especular blanco

Código	W	V	Hz	K	lm	Vida (horas)	Piezas
AFL98A	10	110-240	60	3 000	850	35 000	1

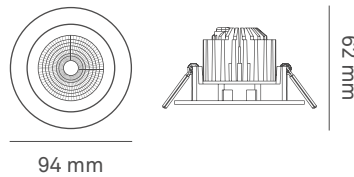
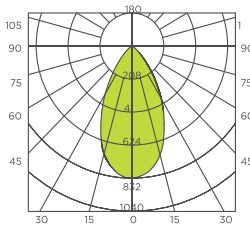

### Luminario circular de empotrar de LED dirigible con reflector cónico especular blanco

Código	W	V	Hz	K	lm	Vida (horas)	Piezas
AF8063L	25	110-240	60	4 200	2 010	35 000	1

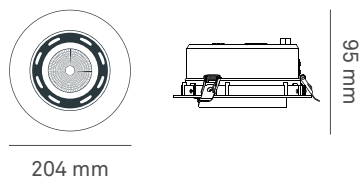
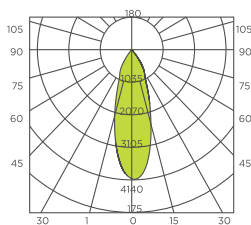



## Luminario circular de empotrar de LED dirigible blanco

Código	W	V	Hz	K	lm	Vida (horas)	Piezas
A1D-1L8S27-G-A1/30	3	120-240	60	2 700	240	35 000	1

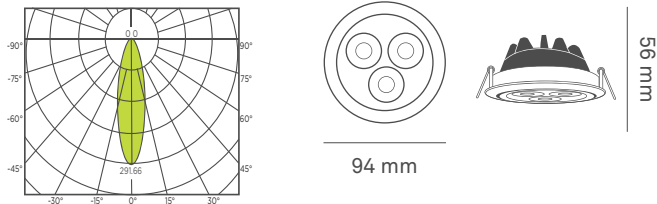

## Luminario circular de empotrar de LED dirigible con reflector cónico especular blanco

Código	W	V	Hz	K	lm	Vida (horas)	Piezas
AFL76	6.5	110-240	60	3 000	530	35 000	1

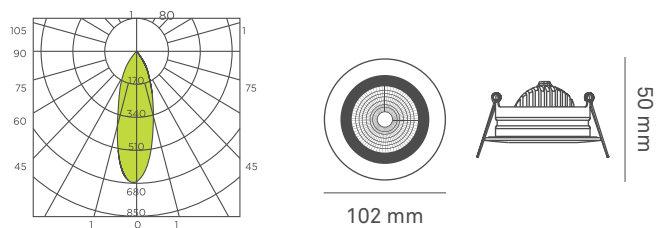

### Luminario circular de sobreponer de LED con difusor de acrílico blanco

Código	W	V	Hz	K	lm	Vida (horas)	Piezas
A4F-1L8S27-C-B1/200	20	120-240	60	3 000	1 440	35 000	1

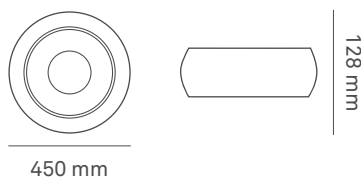
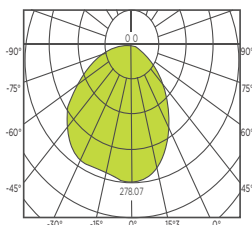

### Luminario circular de sobreponer de LED con acrílico circular blanco

Código	W	V	Hz	K	lm	Vida (horas)	Piezas
AFL78C	20	110-240	60	4 200	1 635	35 000	1

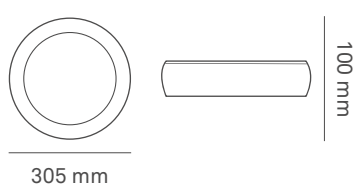
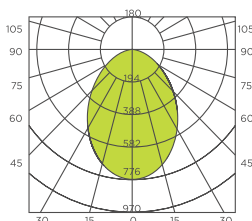

**Luminario circular de sobreponer de LED con difusor de acrílico blanco**

Código	W	V	Hz	K	lm	Vida (horas)	Piezas
AFL78	30	110-240	60	4 200	2 040	35 000	1

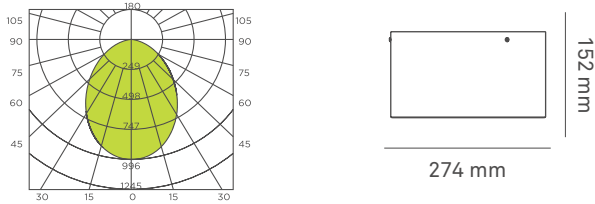

**Luminario circular de sobreponer de LED con difusor de acrílico blanco**

Código	W	V	Hz	K	lm	Vida (horas)	Piezas
AFL78A	15	110-240	60	4 200	1 027	35 000	1

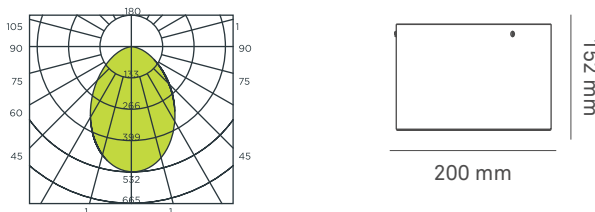

### Luminario circular de sobreponer de LED con reflector de acrílico blanco

Código	W	V	Hz	K	lm	Vida (horas)	Piezas
AF9009BL	10	110-240	60	3 000	850	35 000	1

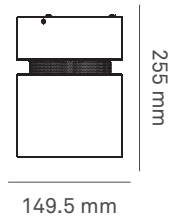
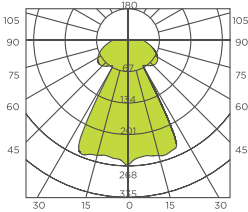

### Luminario circular de sobreponer a techo de LED con difusor de acrílico negro

Código	W	V	Hz	K	lm	Vida (horas)	Piezas
AFWL103L	15	110-240	60	3 000	530	35 000	1

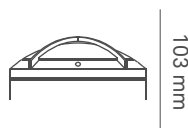
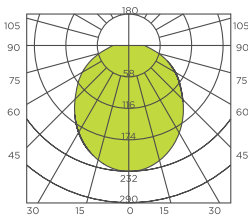

### Luminario tipo cubo de suspender de LED

Código	W	V	Hz	K	lm	Vida (horas)	Piezas
AFL81	15	110-240	60	4 200	1 070	35 000	1

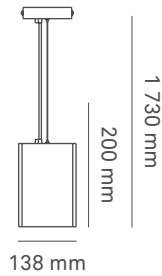
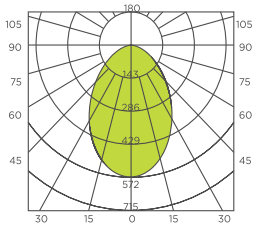

### Luminario circular de suspender de LED con difusor de acrílico blanco

Código	W	V	Hz	K	lm	Vida (horas)	Piezas
A3M-1L8S27-C-B1/200	20	120 -240	60	3 000	1 440	35 000	1

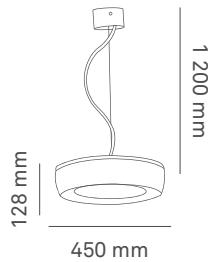
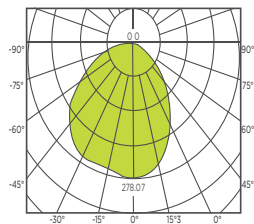

### Luminario tipo cono de suspender de LED

Código	W	V	Hz	K	lm	Vida (horas)	Piezas
AF44L	20	110-240	60	4 200	1 440	35 000	1

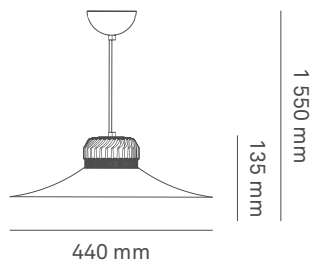
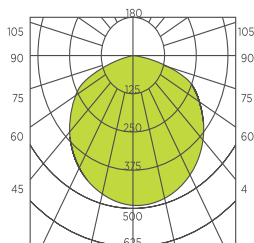

### Luminario tipo cono de suspender de LED

Código	W	V	Hz	K	lm	Vida (horas)	Piezas
AF36BL	20	110-240	60	4 200	1 305	35 000	1

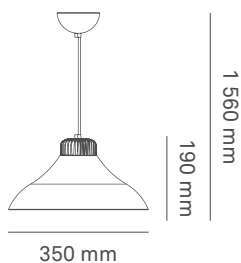
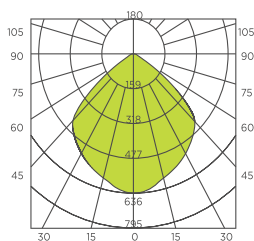

## Luminario tipo campana de suspender de LED

Código	W	V	Hz	K	lm	Vida (horas)	Piezas
AF30BL	35	110-240	60	4 200	2 650	35 000	1

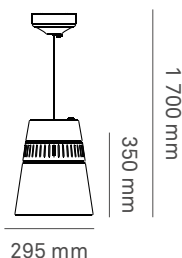
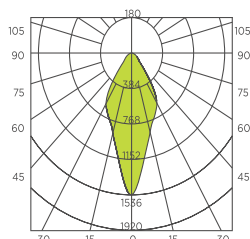

## Luminario tipo campana de suspender de LED

Código	W	V	Hz	K	lm	Vida (horas)	Piezas
AF12JL	30	110-240	60	4 200	2 340	35 000	1

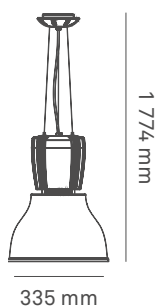
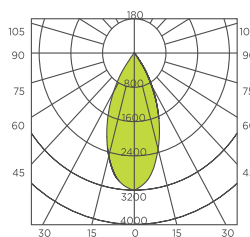

### Luminario tipo campana de suspender de LED

Código	W	V	Hz	K	lm	Vida (horas)	Piezas
AF12CL	30	110-240	60	4 200	2 350	35 000	1

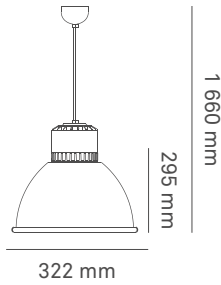
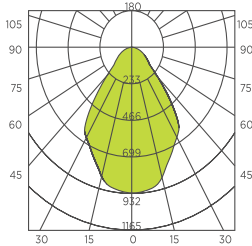

### Luminario colgante de LED

Código	Color	W	V	Hz	K	Base	lm	Vida (horas)	Piezas
9403191	●	18	120-240	60	4 100	E-26	1 200	25 000	6
9403193	○	18	120-240	60	4 100	E-26	1 200	25 000	6
9403194	●	18	120-240	60	4 100	E-26	1 200	25 000	6
9403195	●	18	120-240	60	4 100	E-26	1 200	25 000	6
9403196	●	18	120-240	60	4 100	E-26	1 200	25 000	6
9403197	●	18	120-240	60	4 100	E-26	1 200	25 000	6

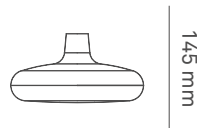
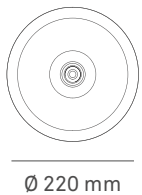



## Luminario rectangular de sobreponer en riel de LED blanco

Código	W	V	Hz	K	lm	Vida (horas)	Piezas
A7M-1L8S27-C-B0/80	8	120-240	60	2 700	580	35 000	1

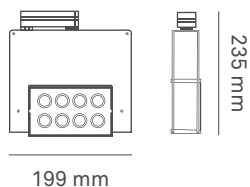
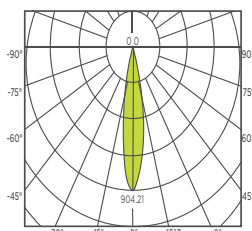

## Luminario circular de sobreponer en riel de LED blanco

Código	W	V	Hz	K	lm	Vida (horas)	Piezas
A7M-1L8S27-C-B0/90	9	120-240	60	2 700	600	35 000	1

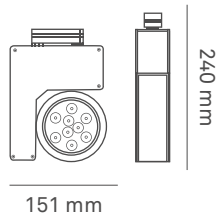
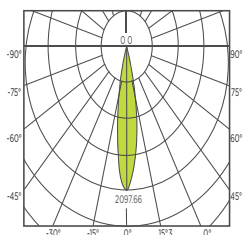

## Luminario circular de sobreponer en riel de LED blanco

Código	W	V	Hz	K	lm	Vida (horas)	Piezas
A7M-1L8S27-C-B0/60	6	120-240	60	2 700	440	35 000	1

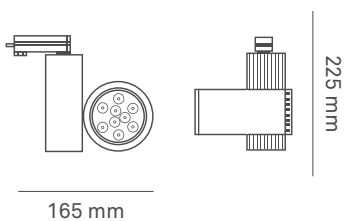
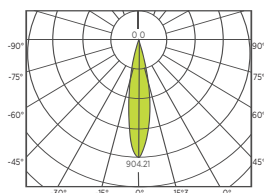

## Luminario circular de sobreponer en riel de LED con reflector cónico espejador blanco

Código	W	V	Hz	K	lm	Vida (horas)	Piezas
A7M-1L8S27-C-B0/230	23	120-240	60	2 700	1 610	35 000	1

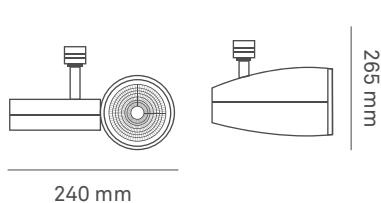
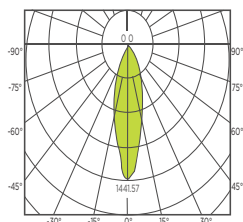

## Luminario circular de sobreponer en riel de LED con reflector cónico especular blanco

Código	W	V	Hz	K	lm	Vida (horas)	Piezas
AFST122BL	25	110-240	60	4 200	2 010	35 000	1

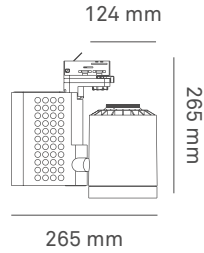
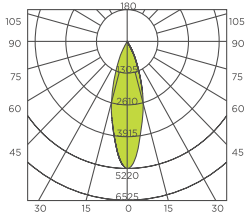

## Luminario circular de sobreponer en riel de LED con reflector cónico especular blanco

Código	W	V	Hz	K	lm	Vida (horas)	Piezas
AFST135L	35	120-240	60	4 200	3 219	35 000	1

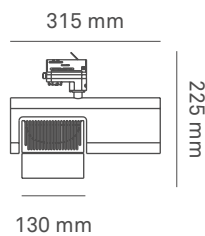
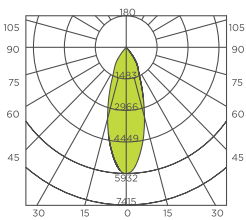

### Luminario circular de sobreponer en riel de LED con reflector cónico especular blanco

Código	W	V	Hz	K	lm	Vida (horas)	Piezas
AFST136CL	35	110-240	60	4 200	2 780	35 000	1

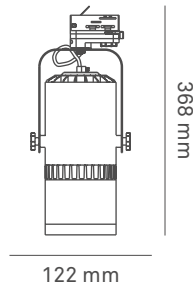
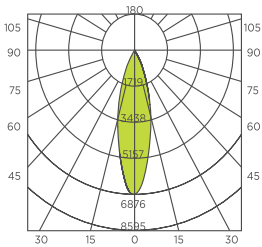

### Luminario circular de sobreponer en riel de LED con reflector cónico especular blanco

Código	W	V	Hz	K	lm	Vida (horas)	Piezas
AFST144L	2x25	110-240	60	4 200	4 005	35 000	1

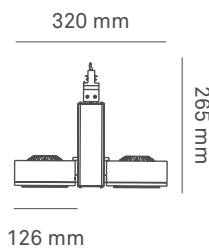
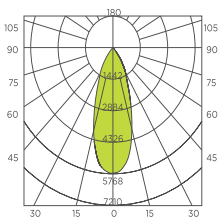

### Luminario rectangular de sobreponer a muro de LED blanco

Código	W	V	Hz	K	lm	Vida (horas)	Piezas
AFWL171	5	110-240	60	3 000	355	35 000	1

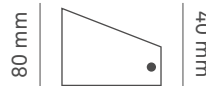
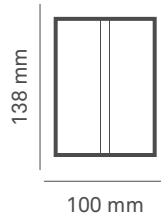
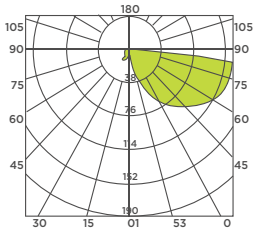
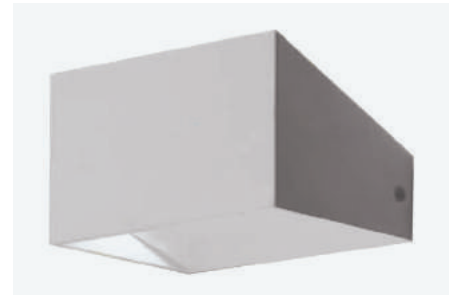

### Luminario rectangular de sobreponer a muro de LED negro

Código	W	V	Hz	K	lm	Vida (horas)	Piezas
AFWL163	3.3	110-240	60	3 000	230	35 000	1

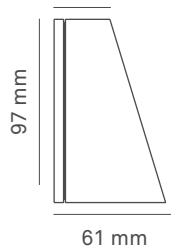
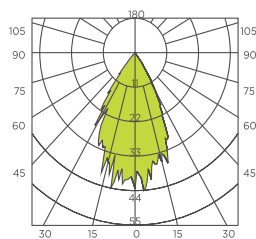

### Luminario circular de sobreponer a muro de LED inclinado negro

Código	W	V	Hz	K	lm	Vida (horas)	Piezas
AFWL162	3.3	110-240	60	3 000	210	35 000	1

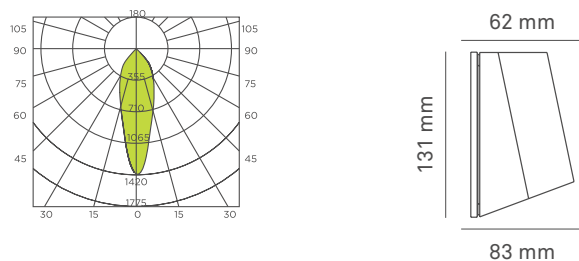
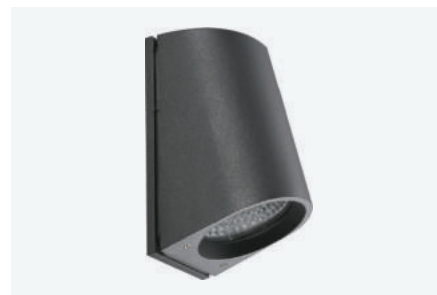

### Luminario circular de sobreponer a muro de LED 2 salidas negro

Código	W	V	Hz	K	lm	Vida (horas)	Piezas
AFWL164	2x3.3	110-240	60	3 000	480	35 000	1

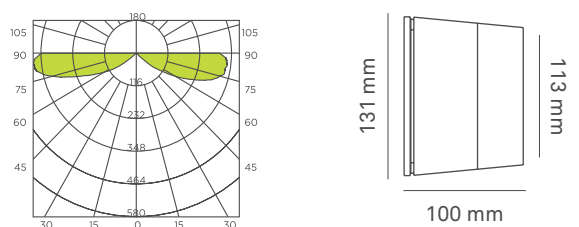

### Luminario circular de sobreponer a muro de LED dirigible gris

Código	W	V	Hz	K	lm	Vida (horas)	Piezas
AF8028L	12	127-240	60	4 200	780	35 000	1

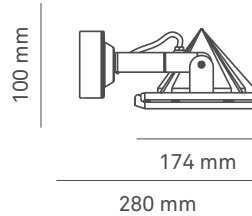
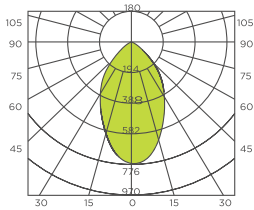

### Luminario cuadrado de sobreponer a muro de LED exterior dirigible blanco

Código	W	V	Hz	K	lm	Vida (horas)	Piezas
A5M-1L8S27-C-B0/150	15	120-240	60	2 700	1 200	35 000	1

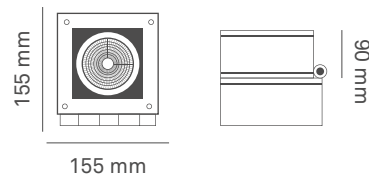
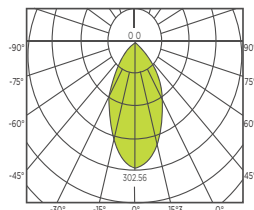

## Luminario tipo pirámide de sobreponer a muro de LED blanco

Código	W	V	Hz	K	lm	Vida (horas)	Piezas
AFWL169	9	110-240	60	3 000	840	35 000	1

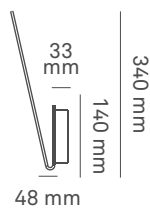
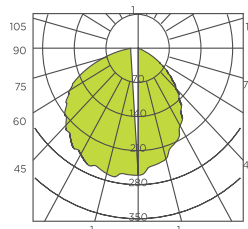



## Luminario cuadrado de empotrar a piso de aluminio

Código	W	V	Hz	K	Dimensiones	lm	Vida	Piezas
					AxB (mm)			
9403061	5	100-277	60	3 000	120x68	500	35 000	1
9403065	12	100-277	60	3 000	160x58	1 200	35 000	1

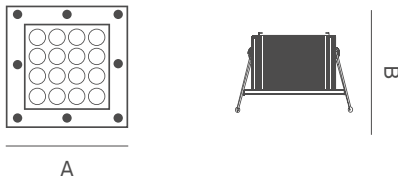
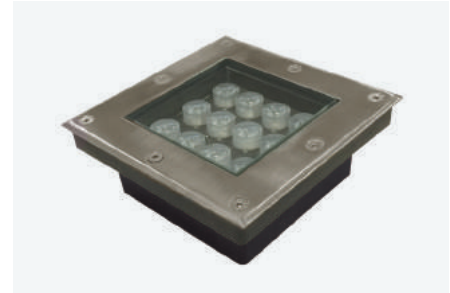

## Luminario circular de empotrar a piso de aluminio

Código	W	V	Hz	K	Dimensiones	lm	Vida	Piezas
					Ø AxB (mm)			
9403051	6	100-277	60	3 000	Ø 150x90	600	35 000	1
9403056	12	100-277	60	3 000	Ø 180x90	1 200	35 000	1

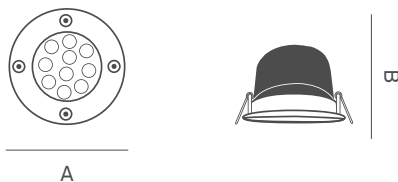

## Lámpara de seguridad ahorradora

Código	Descripción	W	V	Hz	Dimensiones AxBxC (mm)	Piezas
9401050	Lámpara ahorradora	65	127	60	290x270x107	1
9401150	Lámpara ahorradora	85	127	60	305x340x240	1
9401200	Lámpara ahorradora	105	127	60	305x340x240	1

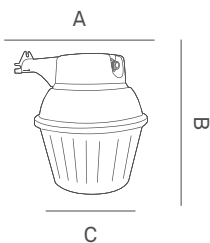

### Características

- Cuerpo de policarbonato.
- Difusor prismático de acrílico.
- Montaje de poste o pared.
- Incluye lámparas fluorescentes compactas y fotocelda.

## Luminario de seguridad ahorrador a prueba de polvo y goteo

Código	Descripción	W	V	Hz	Dimensiones AxBxC (mm)	Piezas
9401300	Luminario ahorrador	36	127	60	590x130x170	1
9401350	Luminario ahorrador	85	127	60	720x200x270	1

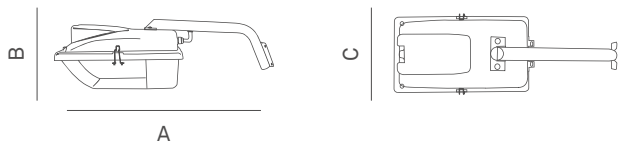

### Características

- Cuerpo de policarbonato.
- Reflector de acero inoxidable.
- Difusor de policarbonato transparente.
- Soporte de brazo para empotrar muros o paredes.
- Incluye fotocelda.
- Incluye lámpara fluorescente compacta.

## Luminario de seguridad a prueba de polvo y goteo de LED

Código	W	V	Hz	K	lm	Vida (horas)	Piezas
9401800	20	127	60	4 100	2 052	50 000	1



### Características

- Cuerpo de policarbonato.
- Reflector de acero inoxidable.
- Difusor de policarbonato transparente.
- Soporte de brazo para empotrar muros o paredes.
- Incluye fotocelda.

## Luminario a prueba de polvo y goteo de LED

Código	W	V	Hz	K	lm	Vida (horas)	Piezas
9401830	30	127-240	60	6 500	2 600	50 000	6

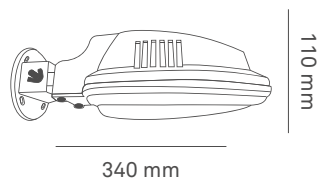

### Características

- Cuerpo de policarbonato.
- Difusor de policarbonato transparente.
- Soporte de brazo para empotrar muros o paredes.
- Incluye fotocelda.

## Luminario reticular para empotrar

### Fluorescente

Código	W	V	Hz	K	Base	Ángulo	Piezas
9400953	42	120-277	50/60	4 100	G5	110°	1
9400954	42	120-127	60	4 100	G5	110°	1
9400966	42	120-277	50/60	6 500	G5	110°	1
9400967	42	120-127	60	6 500	G5	110°	1
9400957	84	120-277	50/60	4 100	G5	110°	1
9400968	84	120-277	50/60	6 500	G5	110°	1

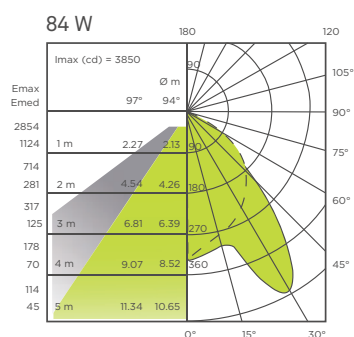
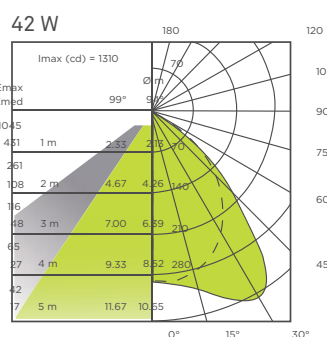

### LED

Código	W	V	Hz	K	Base	Ángulo	Im	Vida	Piezas
								(horas)	
9400950LED41	27	110-277	50/60	4 100	G5	110°	2 700	25 000	1
9400950LED65	27	110-277	50/60	6 500	G5	110°	2 700	25 000	1
9400951LED41	54	110-277	50/60	4 100	G5	110°	5 400	25 000	1
9400951LED65	54	110-277	50/60	6 500	G5	110°	5 400	25 000	1

· Incluye driver y lámparas.

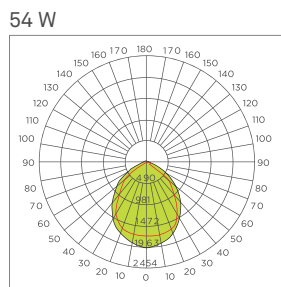
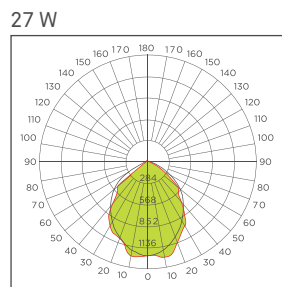

Fluorescente 42 W / LED 27 W

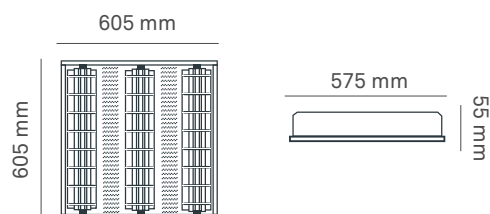

Fluorescente 84 W / LED 54 W

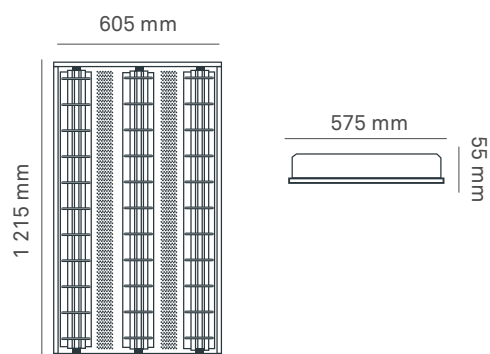

NOTA: Las estructuras de estos luminarios pueden ser adquiridas sin equipo.

## Luminario reticular para sobreponer

### Fluorescente

Código	W	V	Hz	K	Base	Ángulo	Piezas
9400973	42	120-277	50/60	4 100	G5	110°	1
9400978	42	120-277	60	4 100	G5	110°	1
9400974	42	120-277	50/60	6 500	G5	110°	1
9400979	42	120-277	60	6 500	G5	110°	1
9400976	84	120-277	50/60	4 100	G5	110°	1
9400977	84	120-277	50/60	6 500	G5	110°	1

• Incluye balastro electrónico y lámparas.

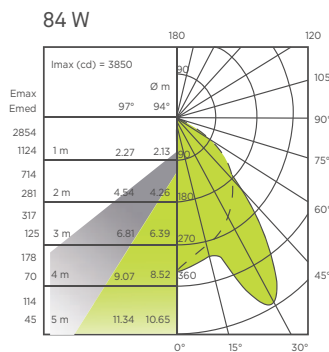
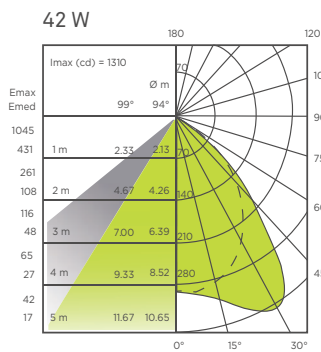

### LED

Código	W	V	Hz	K	Base	Ángulo	lm	Vida (horas)	Piezas
9400971LED41	27	110-277	50/60	4 100	G5	110°	2 700	25 000	1
9400971LED65	27	110-277	50/60	6 500	G5	110°	2 700	25 000	1
9400972LED41	54	110-277	50/60	4 100	G5	110°	5 400	25 000	
9400972LED65	54	110-277	50/60	6 500	G5	110°	5 400	25 000	

• Incluye driver y lámparas.

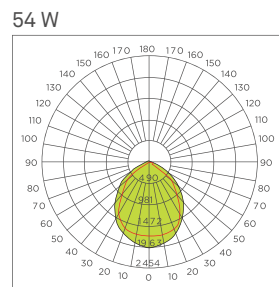
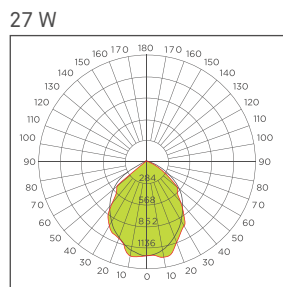

Fluorescente 42 W/LED 27 W

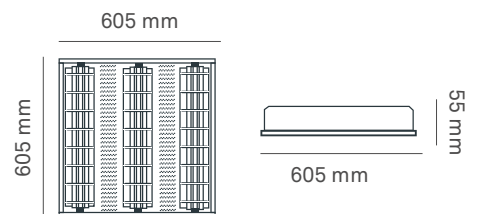

Fluorescente 84 W/ LED 54 W

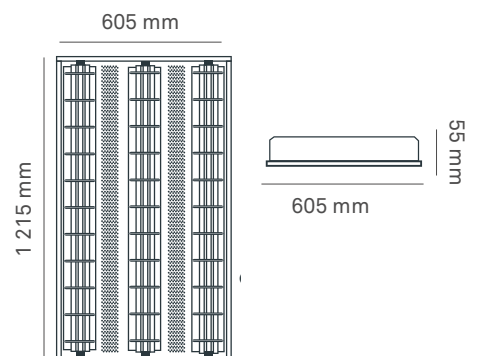

NOTA: Las estructuras de estos luminarios pueden ser adquiridas sin equipo.



## Luminario tipo soft-light de empotrar de LED

Código	W	V	Hz	K	Base	Ángulo	lm	Piezas
A1M-4L13A41-F-B3/360	36	120-277	50/60	4 100	T5	90°	3 600	1

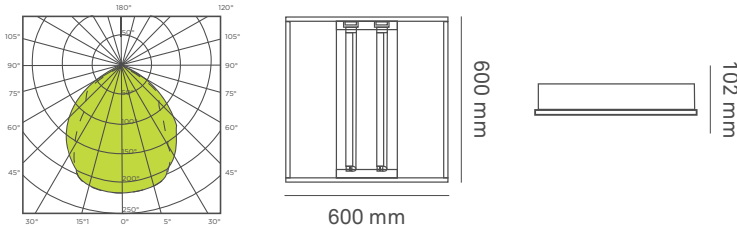

### Carcasa

Código	Cuerpo	Terminado	Aplicaciones	Tipo de lámpara	Lámpara incluida	Base	Piezas
A1M-0S13S0-G-B3/00	Aluminio	Blanco	Empotrar en techo	Tubo T5	No	T5	1

## Luminario tipo soft-light de empotrar de LED

Código	W	V	Hz	K	Base	Ángulo	lm	Piezas
A1M-4L13A41-F-B4/360	36	120-277	50/60	4 100	T5	90°	3 600	1

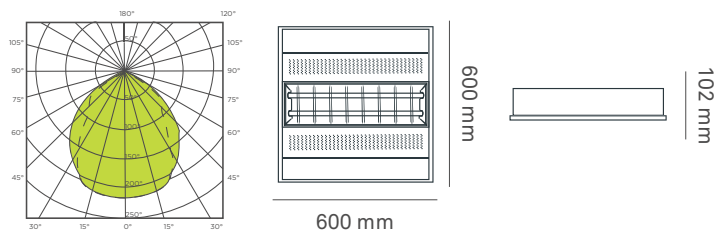

### Carcasa

Código	Cuerpo	Terminado	Aplicaciones	Tipo de lámpara	Lámpara incluida	Base	Piezas
A1M-0S13S0-G-B4/00	Aluminio	Blanco	Empotrar en techo	Tubo T5	No	T5	1

## Luminario rectangular de suspender de LED con 1 lámpara con difusor acrílico aluminio

Código	W	V	Hz	K	Base	Ángulo	lm	Piezas
A3M-1L13F41-F-G-A6/180	18	100 - 277	50/60	4 100	T5	90°	1 800	1

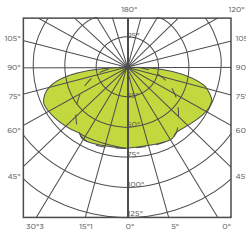

### Carcasa

Código	Cuerpo	Terminado	Aplicaciones	Tipo de lámpara	Lámpara incluida	Base	Piezas
A3M-OS13S0-G-A6/00	Aluminio	Satinado	Suspender en techo	Tubo T5	No	T5	1

## Luminario rectangular de suspender de LED con 1 lámpara con difusor reticular aluminio

Código	W	V	Hz	K	Base	Ángulo	lm	Piezas
A3M-1L13F41-F-G-A7/180	18	100-277	50/60	4 100	T5	90°	1 800	1

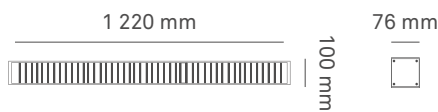
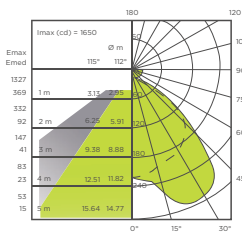

### Carcasa

Código	Cuerpo	Terminado	Aplicaciones	Tipo de lámpara	Lámpara incluida	Base	Piezas
A3M-OS13S0-G-A7/00	Aluminio	Satinado	Suspender en techo	Tubo T5	No	T5	1

## Luminario rectangular de suspender de LED con 2 lámparas con difusor acrílico aluminio

Código	W	V	Hz	K	Base	Ángulo	lm	Piezas
A3M-2L13F41-F-G-A6/360	36	100-277	50/60	4 100	T5	90°	3 600	1

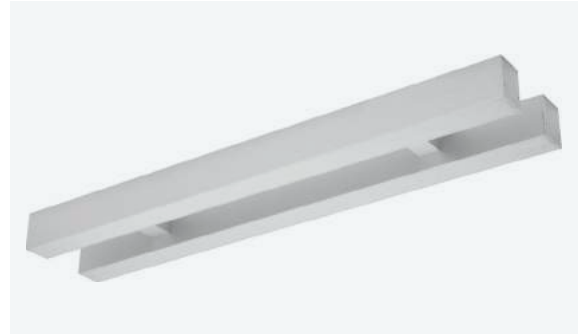
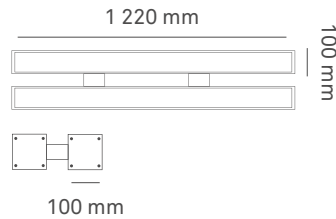
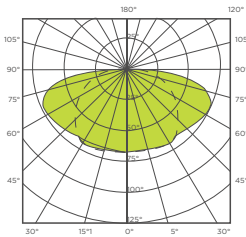

### Carcasa

Código	Cuerpo	Terminado	Aplicaciones	Tipo de lámpara	Lámpara incluida	Base	Piezas
A3M-0S13S0-G-A6/01	Aluminio	Satinado	Suspender en techo	Tubo T5	No	T5	1

## Luminario ovalado de suspender de LED con 4 lámparas con difusor acrílico aluminio

Código	W	V	Hz	K	Base	Ángulo	lm	Piezas
A3M-4L13F41-F-G-A10/720	72	120-277	50/60	4 100	T5	90°	7 200	1

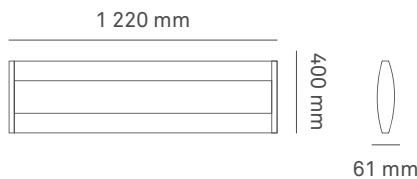
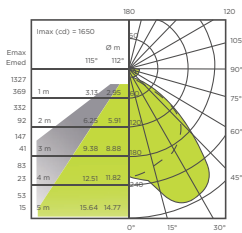

### Carcasa

Código	Cuerpo	Terminado	Aplicaciones	Tipo de lámpara	Lámpara incluida	Base	Piezas
A3M-0S13S0-G-A10/02	Aluminio	Satinado	Empotrar en techo	Tubo T5	No	T5	1



### Luminario panel de LED tipo C 60x60

Código	W	V	Hz	K	Ángulo	lm	Vida (horas)	Piezas
9403112	40	85-265	60	4 100	120°	4 000	50 000	1
9403113	40	85-265	60	3 000	120°	4 000	50 000	1
9403116	40	85-265	60	6 500	120°	4 000	50 000	1

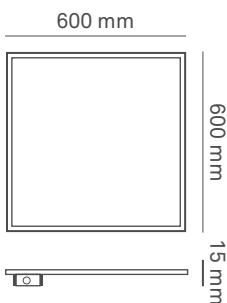
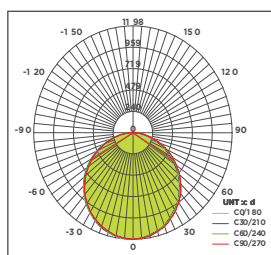

### Luminario panel de LED tipo C 120x30

Código	W	V	Hz	K	Ángulo	lm	Vida (horas)	Piezas
9403117	40	85-265	60	4 100	120°	4 000	50 000	1
9403134	40	85-265	60	6 500	120°	4 000	50 000	1

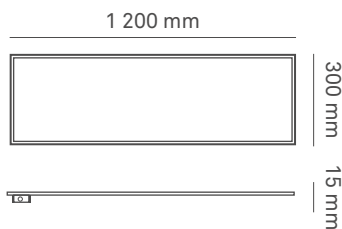
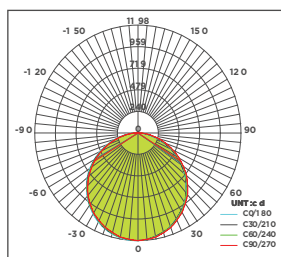

## Luminario panel de LED tipo C 120x60

Código	W	V	Hz	K	Ángulo	lm	Vida (horas)	Piezas
9403119	70	85-265	60	4 100	120°	7 000	50 000	1
9403135	70	85-265	60	6 500	120°	7 000	50 000	1

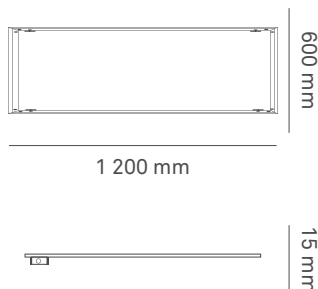
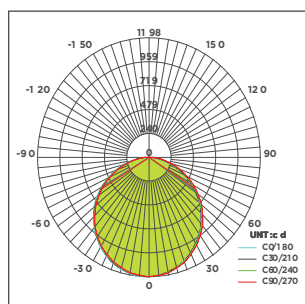

## Accesorios para luminarios paneles de LED tipo C

Código	Descripción	Piezas
9403122	Juego de colgadores para suspender panel de LED tipo C 60x60	1
9403127	Juego de colgadores para suspender panel de LED tipo C 120x30	1
9403124	Juego de colgadores para suspender panel 60x60/120x30	1
9403123	Accesorio para sobreponer panel de LED tipo C 60x60	1
9403128	Accesorio para sobreponer panel de LED tipo C 120x30	1
9403131	Marco para sobreponer panel de LED tipo C 60x60	1
9403132	Marco para sobreponer panel de LED tipo C 120x30	1
9403133	Marco para sobreponer panel de LED tipo C 120x60	1

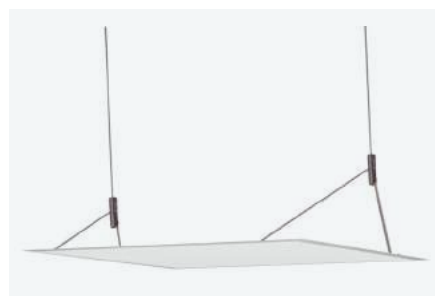

Juego de colgadores para suspender



Accesorio para sobreponer



Marco para sobreponer

## Luminario high bay tipo ESQ

### Fluorescente

Código	W	V	Hz	K	Base	Ángulo	Piezas
9401721*	112	120-277	50/60	—	G5	100°	1
9401722*	216	120-277	50/60	—	G5	100°	1
9401726*	168	120-277	50/60	—	G5	100°	1
9401727*	324	120-277	50/60	—	G5	100°	1
9401740**	216	120-277	50/60	4 100	G5	100°	1
9401745**	324	120-277	50/60	4 100	G5	100°	1
9401741**	216	120-277	50/60	6 500	G5	100°	1
9401746**	324	120-277	50/60	6 500	G5	100°	1



\* No incluye lámparas  
\*\* Incluye balastro electrónico y lámparas

### LED

Código	W	V	Hz	K	Base	Ángulo	lm	Vida (horas)	Piezas
9401725LED41	112	110-277	60	4 100	G5	100°	14 000	25 000	1
9401725LED65	112	110-277	60	6 500	G5	100°	14 000	25 000	1
9401720LED41	168	110-277	60	4 100	G5	100°	21 000	25 000	1
9401720LED65	168	110-277	60	6 500	G5	100°	21 000	25 000	1

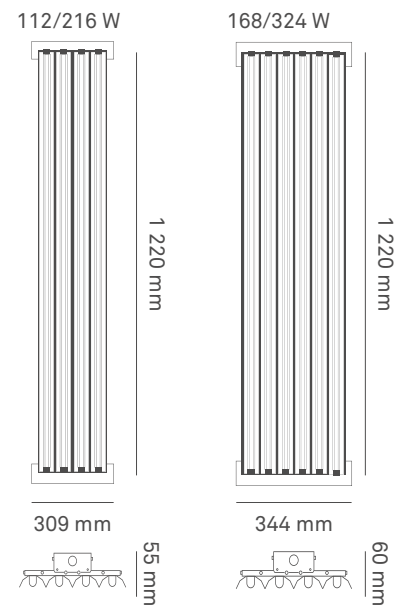

Fluorescente 216 W

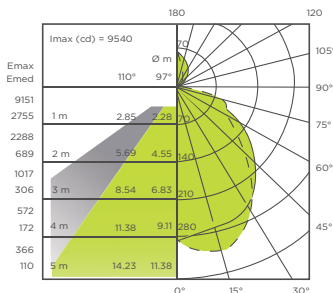

LED 112 W

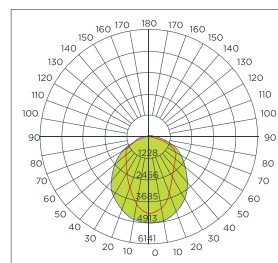

### Estructura

Código	Descripción	Tipo de lámpara	Piezas
9401720	Estructura 4x28/54 W	T5	1
9401725	Estructura 6x28/54 W	T5	1

### Características

- Cuerpo de lámina de acero.
- Pintura electrostática blanca con protector antioxidante.
- Reflector de aluminio especular.
- Incluye bases.

## Luminario high bay tipo gabinete

### Fluorescente

Código	W	V	Hz	K	Base	Ángulo	Piezas
9401701*	112	120-277	50/60	—	G5	100°	1
9401702*	216	120-277	50/60	—	G5	100°	1
9401711*	168	120-277	50/60	—	G5	100°	1
9401712*	324	120-277	50/60	—	G5	100°	1
9401730**	216	120-277	50/60	4 100	G5	100°	1
9401735**	324	120-277	50/60	4 100	G5	100°	1
9401731**	216	120-277	50/60	6 500	G5	100°	1
9401736**	324	120-277	50/60	6 500	G5	100°	1



\* No incluye lámparas

\*\* Incluye balastro electrónico y lámparas

### LED

Código	W	V	Hz	K	Base	Ángulo	lm	Vida	Piezas
								(horas)	
9401700LED41	112	110-277	60	4 100	G5	100°	14 000	25 000	1
9401700LED65	112	110-277	60	6 500	G5	100°	14 000	25 000	1
9401710LED41	168	110-277	60	4 100	G5	100°	21 000	25 000	1
9401710LED65	168	110-277	60	6 500	G5	100°	21 000	25 000	1

112/216 W

168/324 W

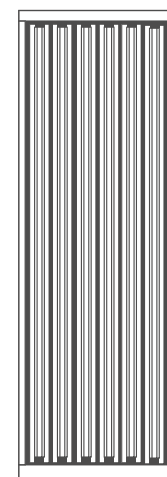
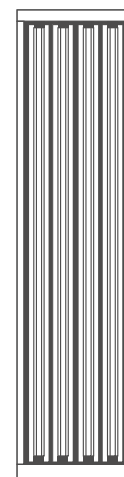

285 mm

410 mm

96 mm

96 mm



Fluorescente 216 W

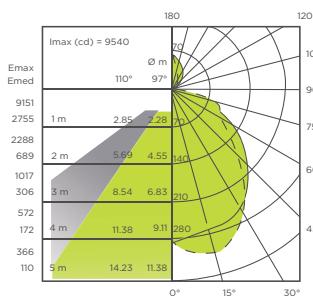

LED 112 W

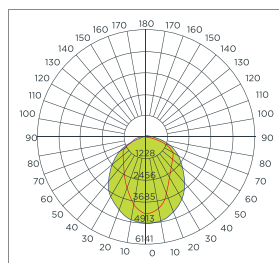

### Estructura

Código	Descripción	Tipo de lámpara	Piezas
9401700	Estructura 4x28/54 W	T5	1
9401710	Estructura 6x28/54 W	T5	1

### Características

- Cuerpo de lámina de acero.
- Pintura electrostática blanca con protector antioxidante.
- Reflector de aluminio especular.
- Incluye bases.

## Luminario high bay de LED

Código	W	V	Hz	K	Ángulo	lm	Vida	Piezas
							(horas)	
9401750	100	90-305	50 / 60	5 000	120°	13 000	35 000	1
9401755	200	90-305	50 / 60	5 000	120°	26 000	35 000	1



### Características

- Cuerpo de lámina de acero.
- Pintura electrostática blanca con protector antioxidante.
- Reflector de aluminio especular.
- Incluye bases.
- Cuenta con certificación UL

9401750

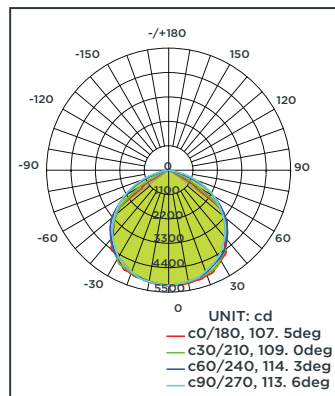

9401755

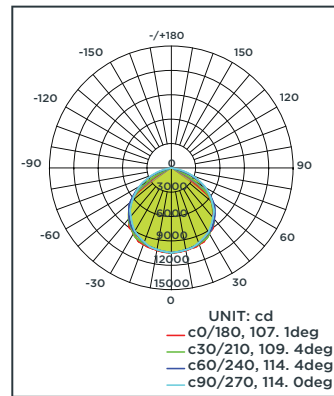

9401750

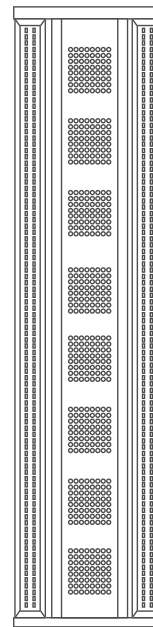

1 094 mm

9401755

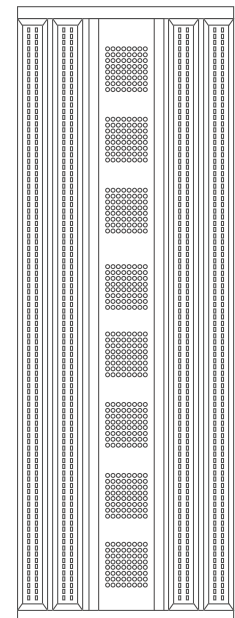

1 094 mm

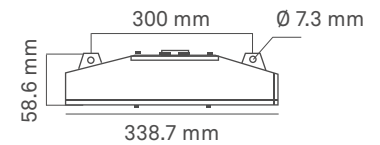
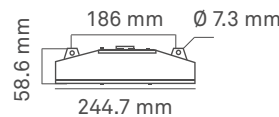

## Luminario circular high bay de LED

Código	W	V	Hz	K	Ángulo	lm	Vida (horas)	Piezas
9401780	150	90-305	60	5 000	120°	19 000	50 000	1
9401785	200	90-305	60	5 000	120°	26 000	50 000	1

· Cuenta con certificación UL

9401780

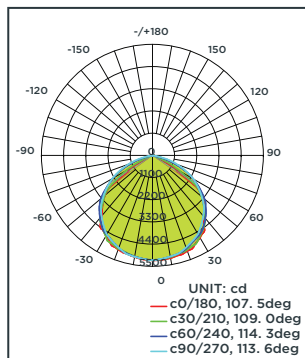

9401785

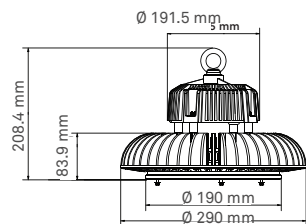
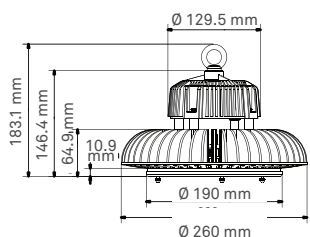
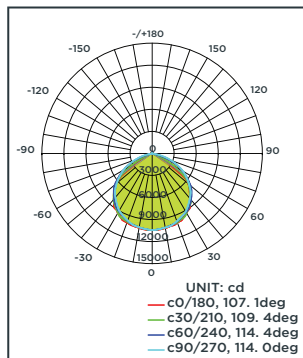

## Campana de aluminio para luminario circular high bay

Código	Descripción	Piezas
CAM60AL	Campana de aluminio 60°	1
CAM90AL	Campana de aluminio 90°	1
CAM70PC	Campana de aluminio 70°	1



## Soporte para luminario circular high bay

Código	Descripción	Piezas
9401786	Soporte para campana de LED	1





## Luminario a prueba de polvo y goteo T8

Código	Descripción	V	Hz	K	Base	Tipo de lámpara	Ángulo	Piezas
9400504A*	1x17 W	120-277	50/60	—	G13	T8	80°	1
9400504B*	1x17 W	120-127	60	—	G13	T8	80°	1
9400506A*	2x17 W	120-277	50/60	—	G13	T8	80°	1
9400506B*	2x17 W	120-127	60	—	G13	T8	80°	1
9400504BT41**	1x17 W	120-127	60	4 100	G13	T8	80°	1
9400504AT41**	1x17 W	120-277	50/60	4 100	G13	T8	80°	1
9400504BT65**	1x17 W	120-127	60	6 500	G13	T8	80°	1
9400504AT65**	1x17 W	120-277	50/60	6 500	G13	T8	80°	1
9400506BT41**	2x17 W	120-127	60	4 100	G13	T8	80°	1
9400506AT41**	2x17 W	120-277	50/60	4 100	G13	T8	80°	1
9400506BT65**	2x17 W	120-127	60	6 500	G13	T8	80°	1
9400506AT65**	2x17 W	120-277	50/60	6 500	G13	T8	80°	1
9400515B*	1x32 W	120-127	60	—	G13	T8	80°	1
9400515A*	1x32 W	120-277	50/60	—	G13	T8	80°	1
9400510B*	2x32 W	120-127	60	—	G13	T8	80°	1
9400510A*	2x32 W	120-277	50/60	—	G13	T8	80°	1
9400515BT41**	1x32 W	120-127	60	4 100	G13	T8	80°	1
9400515BT65**	1x32 W	120-127	60	6 500	G13	T8	80°	1
9400515AT41**	1x32 W	120-277	50/60	4 100	G13	T8	80°	1
9400515AT65**	1x32 W	120-277	50/60	6 500	G13	T8	80°	1
9400510BT41**	2x32 W	120-127	60	4 100	G13	T8	80°	1
9400510BT65**	2x32 W	120-127	60	6 500	G13	T8	80°	1
9400510AT41**	2x32 W	120-277	50/60	4 100	G13	T8	80°	1
9400510AT65**	2x32 W	120-277	50/60	6 500	G13	T8	80°	1

\* No incluye lámparas

\*\* Incluye balastro electrónico y lámparas



Powered by  
**PHILIPS**



## Luminario a prueba de polvo y goteo T5

Código	Descripción	V	Hz	K	Base	Tipo de lámpara	Ángulo	Piezas
9400505P*	1x14 W	120-277	50/60	—	G5	T5	80°	1
94005007P*	2x14 W	120-277	50/60	—	G5	T5	80°	1
9400505PT41**	1x14 W	120-277	50/60	4 100	G5	T5	80°	1
9400505PT65**	1x14 W	120-277	50/60	6 500	G5	T5	80°	1
9400507PT41**	2x14 W	120-277	50/60	4 100	G5	T5	80°	1
9400507PT65**	2x14 W	120-277	50/60	6 500	G5	T5	80°	1
9400515P*	1 x28 W	120-277	50/60	—	G5	T5	80°	1
9400525P*	1x54 W	120-277	50/60	—	G5	T5	80°	1
9400510P*	2x28 W	120-277	50/60	—	G5	T5	80°	1
9400520P*	2x54 W	120-277	50/60	—	G5	T5	80°	1
9400515PT41**	1x28 W	120-277	50/60	4 100	G5	T5	80°	1
9400515PT65**	1x28 W	120-277	50/60	6 500	G5	T5	80°	1
9400525PT41**	1x54 W	120-277	50/60	4 100	G5	T5	80°	1
9400525PT65**	1x54 W	120-277	50/60	6 500	G5	T5	80°	1
9400510PT41**	2x28 W	120-277	50/60	4 100	G5	T5	80°	1
9400510PT65**	2x28 W	120-277	50/60	6 500	G5	T5	80°	1
9400520PT41**	2x54 W	120-277	50/60	4 100	G5	T5	80°	1
9400520PT65**	2x54 W	120-277	50/60	6 500	G5	T5	80°	1

\* No incluye lámparas

\*\* Incluye balastro electrónico y lámparas



Powered by  
**PHILIPS**





### Luminario a prueba de polvo y goteo con tubos de LED Philips

Código	W	V	Hz	K	lm	Vida (horas)	Piezas
9400509LED41	36	100-240	50/60	4 100	3 600	30 000	1
9400509LED65	36	100-240	50/60	6 500	3 600	30 000	1

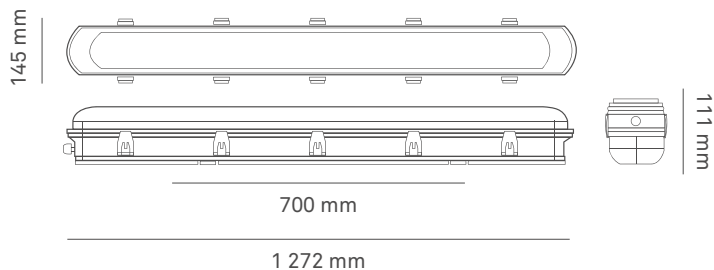

### Luminario a prueba de polvo y goteo con tubos de LED Argos

Código	W	V	Hz	K	lm	Vida (horas)	Piezas
9400511LED41	36	100-277	50/60	4 100	3 600	30 000	1
9400511LED65	36	100-277	50/60	6 500	3 600	30 000	1

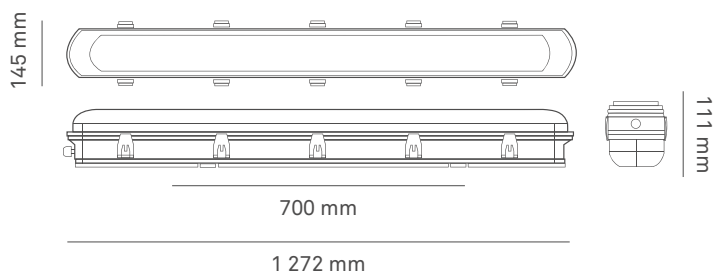

### Luminario a prueba de polvo y goteo de LED

Código	W	V	Hz	K	lm	Vida (horas)	Piezas
9400545LED41	36	120-277	50/60	4 100	4 680	30 000	1

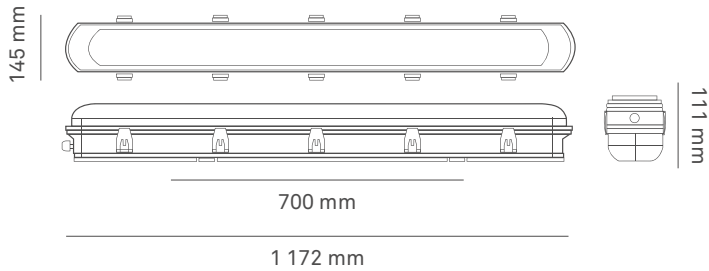

### Luminario a prueba de polvo y goteo de LED con disipador de calor

Código	W	V	Hz	K	lm	Vida (horas)	Piezas
9400540LED41	36	120-277	50/60	4 100	4 680	30 000	1



· Incluye disipador de calor.

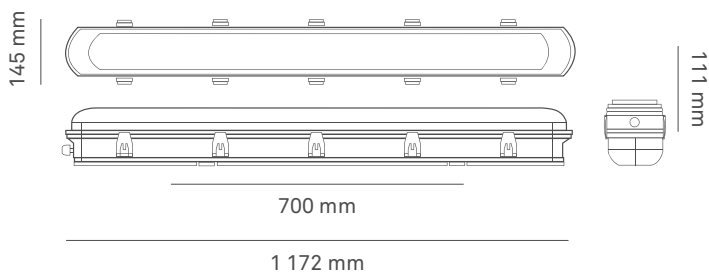

### Estructura tipo urbano

Código	Descripción	W	Piezas
9402250	Carcasa para luminario tipo urbano	250	2

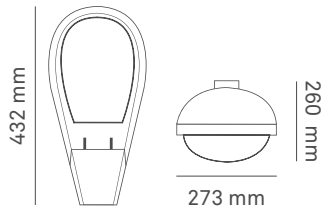

### Refacciones

Código	Descripción	Piezas
9402251	Cristal para luminario industrial OV250	8

### Luminario tipo urbano de LED

Código	W	V	Hz	K	Dimensiones	lm	Tipo de LED	Vida	Piezas
					AxBxC (mm)				
9402282	50	90-305	60	6 000	650x236x120	4 500	NICHIA	50 000	1
9402284	100	90-305	60	6 000	810x280x120	9 000	NICHIA	50 000	1
9402286	150	90-305	60	6 000	810x280x120	13 500	NICHIA	50 000	1

· Incluyen fotocelda

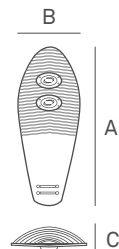
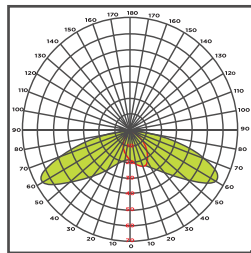

### Luminario wall pack de LED alto brillo

Código	W	V	Hz	K	lm	Tipo de LED	Vida (horas)	Piezas
ARLED107	40	100-277	60	5 000	4 800	NICHIA	50 000	1

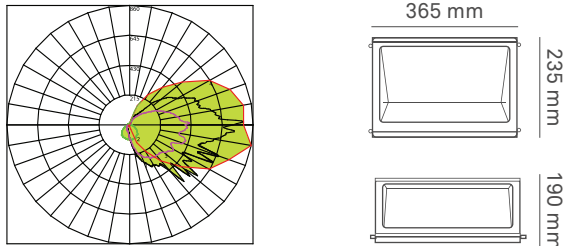

### Luminario cuadrado wall pack de LED alto brillo

Código	W	V	Hz	K	lm	Tipo de LED	Vida (horas)	Piezas
ARLED302	40	100-277	60	4 700	5 000	NICHIA	50 000	1

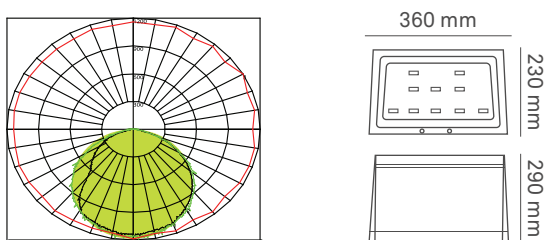

### Luminario tipo estacionamiento de LED

Código	W	V	Hz	K	lm	Tipo de LED	Vida (horas)	Piezas
ARLED365	40	100-277	60	5 000	4 900	NICHIA	50 000	1

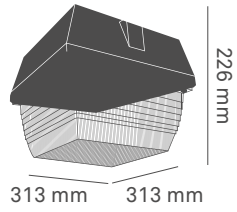
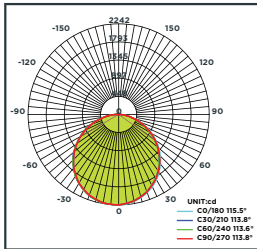

### Lámparas de emergencia 3.6 V

Código	Descripción	W	V	Hz	Duración (minutos)	Piezas
9401575	Lámpara de emergencia 3.6 V- LED	4	127	60	90	1

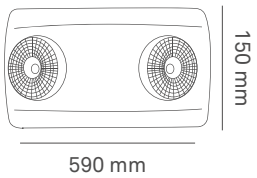

## Luminario circular high bay de LED

Código	W	V	Hz	K	Ángulo	lm	Vida (horas)	Piezas
9401780	150	90-305	60	5 000	120°	19 000	50 000	1
9401785	200	90-305	60	5 000	120°	26 000	50 000	1

· Cuenta con certificación UL

9401780

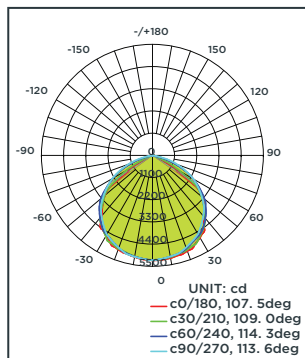

9401785

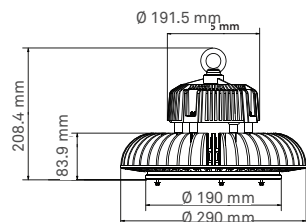
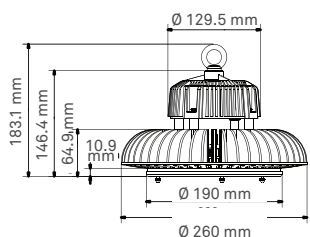
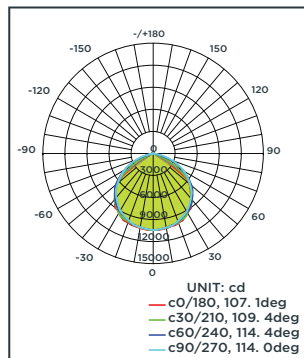

## Campana de aluminio para luminario circular high bay

Código	Descripción	Piezas
CAM60AL	Campana de aluminio 60°	1
CAM90AL	Campana de aluminio 90°	1
CAM70PC	Campana de aluminio 70°	1



## Soporte para luminario circular high bay

Código	Descripción	Piezas
9401786	Soporte para campana de LED	1



## Estructura a prueba de polvo y goteo

Código	Descripción	Dimensiones	Piezas
		AxBxCxD (mm)	
9400504	Estructura 1x17 W	662x350x1111x95	1
9400505	Estructura 1x14 W	662x350 x111x95	1
9400506	Estructura 2x17 W	662x350x1111x145	1
9400507	Estructura 2x14 W	662x350x111x145	1
9400515	Estructura 1x32 W	1 272x700x1111x95	1
9400517	Estructura 1x28/54 W	1 272x700x1111x95	1
9400510	Estructura 2x32 W	1 272x700x111x145	1
9400512	Estructura 2x28/54 W	1 272x700x111x145	1



## Características

- Cuerpo de policarbonato color gris RAL7035.
- Difusor de policarbonato transparente.
- Empaque de poliuretano expandido.
- Reflector de lámina de acero pintado electrostáticamente en blanco.
- Juego de herrajes para montaje suspendido o sobreponer en el techo.

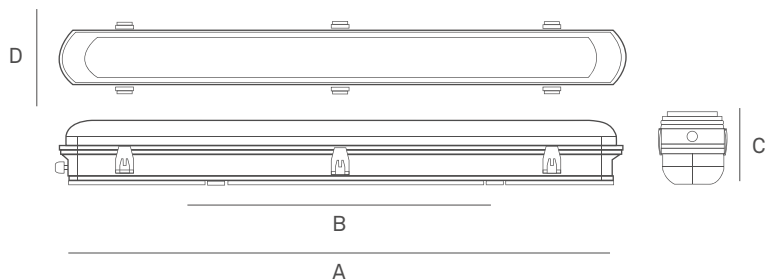

### Estructura tipo urbano

Código	Descripción	W	Piezas
9402250	Carcasa para luminario tipo urbano	250	2

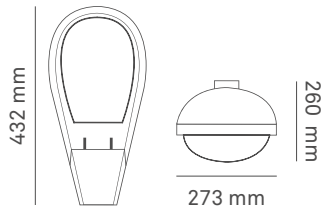

### Refacciones

Código	Descripción	Piezas
9402251	Cristal para luminario industrial OV250	8

### Luminario tipo urbano de LED

Código	W	V	Hz	K	Dimensiones	lm	Tipo de LED	Vida	Piezas
					AxBxC (mm)				
9402282	50	90-305	60	6 000	650x236x120	4 500	NICHIA	50 000	1
9402284	100	90-305	60	6 000	810x280x120	9 000	NICHIA	50 000	1
9402286	150	90-305	60	6 000	810x280x120	13 500	NICHIA	50 000	1

· Incluyen fotocelda

