

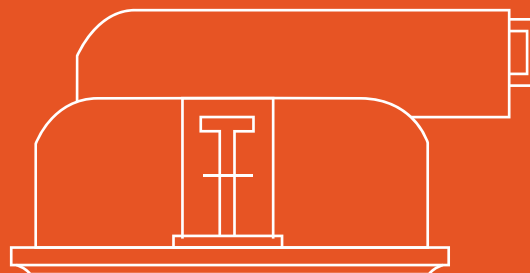

ILUMINACIÓN

Pág. 123-216

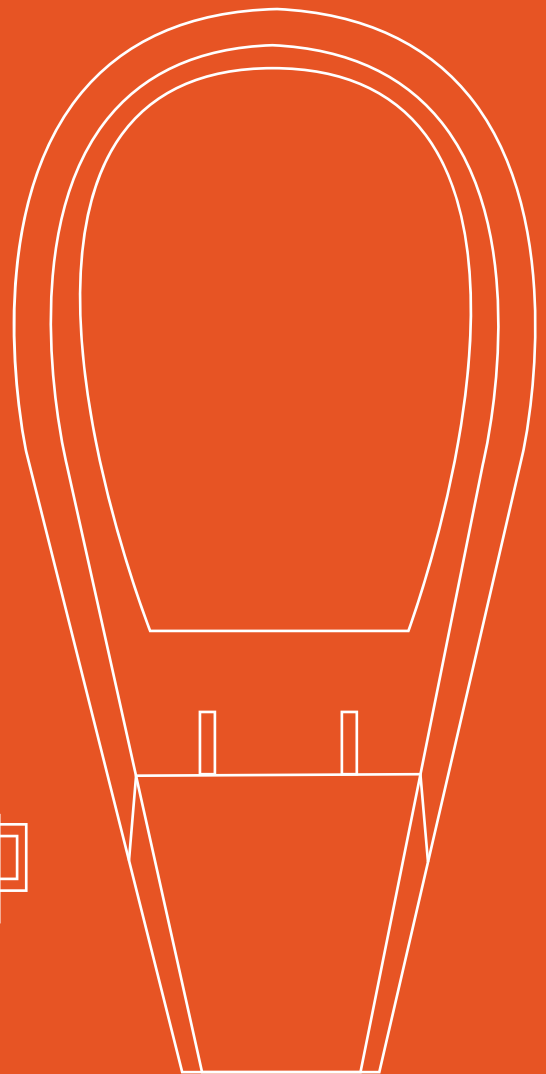
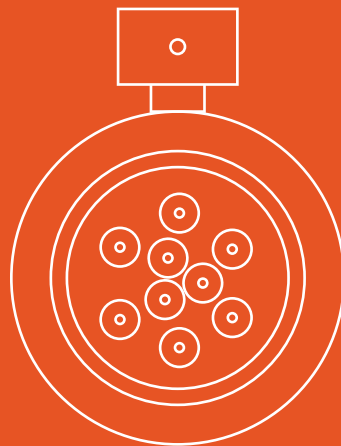

ILUMINACIÓN

Foco horno refrigerador

Código	W	V	Hz	Base	Bulbo	lm	Vida (horas)	Piezas
8900800	25	127	60	E-26	A15 Claro	250	1 000	10
8900810	40	127	60	E-26	A15 Claro	365	1 000	10

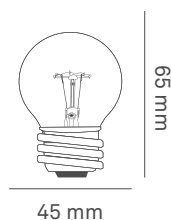

Foco vela

Código	W	V	Hz	Base	Bulbo	lm	Vida (horas)	Piezas
8900820	40	127	60	E-26	BA9 Claro	460	1 000	10
8900830	40	127	60	E-14	BA9 Claro	460	1 000	10

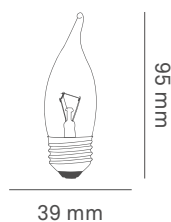



Foco flama

Código	W	V	Hz	Base	Bulbo	lm	Vida (horas)	Piezas
8900840	40	127	60	E-26	F15 Claro	420	1 000	10
8900850	40	127	60	E-26	F15 Perla	420	1 000	10

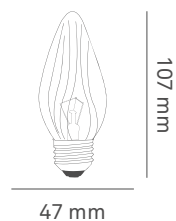

Reflector de halógeno PAR

Código	W	V	Hz	Dimensiones AxB (mm)	Base	Bulbo	lm	Vida (horas)	Piezas
8900700	50	127	60	63x80	E-26	PAR 20	760	2 000	10
8900710	75	127	60	97x90	E-26	PAR 30	1 000	2 000	10
8900720	90	127	60	222x130	E-26	PAR 38	1 440	2 000	10

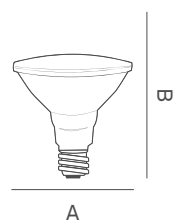

Lámpara halógena dicroica MR-16 GU5.3

Código	W	V	Hz	Bulbo	Ángulo	lm	Vida (horas)	Piezas
9400850	50	12	60	MR-16	36	800	2 000	10

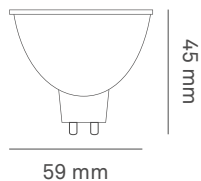

Lámpara halógena dicroica MR-16 GU10 con cubierta

Código	W	V	Hz	Bulbo	Ángulo	lm	Vida (horas)	Piezas
9400876	50	127	60	MR-16	36	800	2 000	10

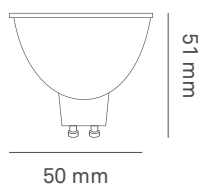



Lámpara fluorescente compacta autobalastada 4U T3

Código	W	V	Hz	K	Base	Bulbo	lm	Vida (horas)	Piezas
8900400	36	127	60	6 400	E-26	T3	2 034	6 000	40

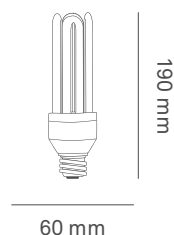
NOM

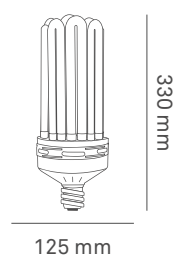

Lámpara fluorescente compacta autobalastada 8U T3

Código	W	V	Hz	K	Base	Bulbo	lm	Vida (horas)	Piezas
8900500	150	220	60	6 400	E-40	T3	8 475	8 000	12
8900505	150	127	60	6 400	E-40	T3	8 475	8 000	12

NOM

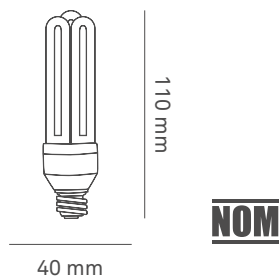

Lámpara fluorescente compacta mini 3U T2

Código	W	V	Hz	K	Base	Bulbo	lm	Vida (horas)	Piezas
8900335	15	127	60	2 700	E-26	T2	713	8 000	10

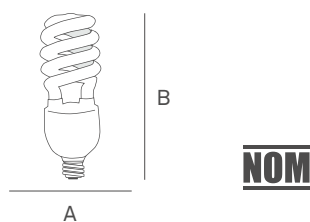

Lámpara fluorescente compacta autobalastada espiral T3

Código	W	V	Hz	K	Dimensiones AxB (mm)	Base	Bulbo	lm	Vida (horas)	Piezas
8900010	11	127	60	6 400	55x137	E-26	T3	556	8 000	50
8900020	13	127	60	6 400	56x100	E-26	T3	598	8 000	50
8900030	15	127	60	6 400	59x131	E-26	T3	819	8 000	50
8900040	20	127	60	6 400	55x137	E-26	T3	1 040	8 000	50
8900050	25	127	60	6 400	60x151	E-26	T3	1 443	8 000	50
8900055	45	127	60	6 400	85x260	E-26	T3	2 925	8 000	20
8900060	65	127	60	6 400	75x250	E-26	T3	3 673	8 000	20
8900070	85	127	60	6 400	102x290	E-26	T3	4 802	8 000	20
8900075	85	127	60	6 400	102x290	E-40	T3	4 880	8 000	20
8900078	85	220	60	6 400	102x290	E-40	T3	4 880	8 000	20
8900080	105	127	60	6 400	102x290	E-26	T3	5 900	8 000	20



Lámpara de LED

Código	W	V	Hz	K	Dimensiones	Base	Bulbo	lm	Vida	Piezas
					AxB (mm)				(horas)	
9403003 *	10	127-240	60	3 000	60x113	E-26	A-60	800	30 000	100
9403004 *	10	127-240	60	6 500	60x113	E-26	A-60	800	30 000	100
9403040	16	100-240	60	6 500	80x154	E-26	A-80	1 800	30 000	1
9403042	20	100-240	60	6 500	95x168	E-26	A-95	2 300	30 000	1
9403044	36	100-240	60	6 500	120x202	E-26	T-120	4 000	30 000	1
9403046	45	100-240	60	6 500	140x232	E-26	T-140	5 000	30 000	1
9403048	55	100-240	60	6 500	160x275	E-26	A-160	6 000	30 000	1
9403011	9	100-240	60	3 000	60x110	E-26	A-60	810	30 000	100
9403012	9	100-240	60	6 500	60x110	E-26	A-60	810	30 000	100
9403013	12	100-240	60	3 000	60x118	E-26	A-60	1 150	30 000	50
9403014	12	100-240	60	6 500	60x118	E-26	A-60	1 150	30 000	50

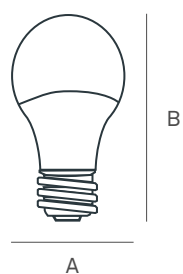

Lámpara MR16 GU10 de LED

Código	W	V	Hz	K	Base	Bulbo	lm	Vida (horas)	Piezas
9403360	5	100-127	60	3 000	GU10	MR16	400	30 000	100
9403361	5	100-127	60	6 500	GU10	MR16	400	30 000	100

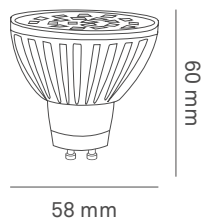

NOM

LED



Lámpara MR16 GU10 de LED de colores

Código	Color	W	V	Hz	K	Base	Bulbo	lm	Vida (horas)	Piezas
9403362	●	2.3	100-127	60	3 000	GU10	MR16	130	25 000	100
9403363	●	2.3	100-127	60	3 000	GU10	MR16	130	25 000	100
9403364	●	2.3	100-127	60	3 000	GU10	MR16	130	25 000	100
9403365	●	2.3	100-127	60	3 000	GU10	MR16	130	25 000	100

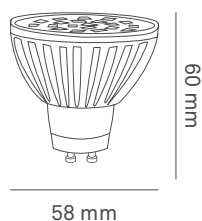

NOM

LED





Lámpara JDR de LED

Código	W	V	Hz	K	Base	Bulbo	lm	Vida (horas)	Piezas
9403370	5	100-127	60	3 000	E-26	JDR	400	30 000	10
9403371	5	100-127	60	6 500	E-26	JDR	400	30 000	10

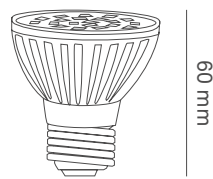

60 mm

NOM
LED

58 mm



Lámpara JDR de LED de colores

Código	Color	W	V	Hz	Base	Bulbo	lm	Vida (horas)	Piezas
9403372	●	2.3	100-127	60	E-26	JDR	130	25 000	10
9403373	●	2.3	100-127	60	E-26	JDR	130	25 000	10
9403374	●	2.3	100-127	60	E-26	JDR	130	25 000	10
9403375	●	2.3	100-127	60	E-26	JDR	130	25 000	10

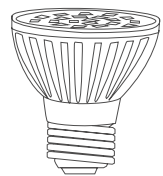

60 mm

NOM
LED

58 mm



Lámpara PAR de LED

Código	W	V	Hz	K	Dimensiones	Base	Bulbo	lm	Vida	Piezas
					AxB (mm)					
9403072	12	100-240	60	3 000	95x85	E 26	PAR 30	1 150	25 000	1
9403074	16	100-240	60	3 000	120x124	E 26	PAR 38	1 480	25 000	1

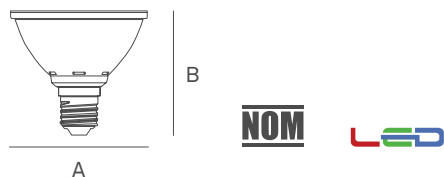

Lámparas de alta potencia de LED

Código	W	V	Hz	K	Dimensiones	Base	lm	Vida	Piezas
					AxB (mm)				
9403080	60	100-277	60	5 000	90x280	E-40	6 600	30 000	1
9403082	80	100-277	60	5 000	120x260	E-40	9 200	30 000	1

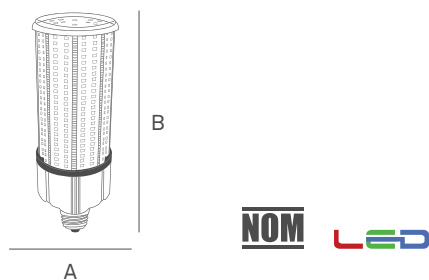



Lámpara lineal de LED (Tubo T5)

Código	W	V	Hz	K	Longitud (mm)	Base	Bulbo	lm	Vida (horas)	Piezas
9403280	9	110-277	50/60	4 100	560	G5	T5	900	30 000	1
9403282	9	110-277	50/60	6 500	560	G5	T5	900	30 000	1
9403284	18	110-277	50/60	4 100	1 160	G5	T5	1 800	30 000	1
9403286	18	110-277	50/60	6 500	1 160	G5	T5	1 800	30 000	1
9403287	28	110-277	50/60	4 100	1 150	G5	T5	3 500	30 000	1
9403288	28	110-277	50/60	6 500	1 150	G5	T5	3 500	30 000	1

· Incluye driver externo.



Lámpara lineal de LED (Tubo T8)

Código	W	V	Hz	K	Longitud (mm)	Base	Bulbo	lm	Vida (horas)	Piezas
9403246	18	110-277	50/60	4 100	1 220	G13	T8	1 800	30 000	1
9403269	18	110-277	50/60	6 500	1 220	G13	T8	1 800	30 000	1



Manguera plana de LED

Código	W	V	Hz	K	Longitud	Grado de protección	lm	Vida	Piezas
					(m)			(horas)	
9403203	38	127	60	3 000	5	IP-65	6 000	50 000	1
9403207	38	127	60	6 000	5	IP-65	6 000	50 000	1

- 60 leds por metro.
- Incluye driver.



Driver para manguera plana de LED

Código	W	V	Hz	Piezas
9403210	38	127	60	1



Carcasa circular de empotrar dirigible MR16 blanco

Código	Cuerpo	Terminado	Aplicaciones	Tipo de lámpara	Lámpara incluida	Base	Piezas
A1D-0S3S0-G-B1/00	Aluminio	Blanco	Empotrar en techo	MR16	No	GU10	1

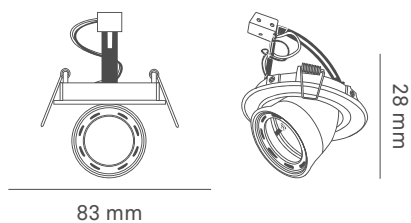

Carcasa circular de empotrar fijo MR16 blanco

Código	Cuerpo	Terminado	Aplicaciones	Tipo de lámpara	Lámpara incluida	Base	Piezas
A1F-0S3S0-G-B2/00	Aluminio	Blanco	Empotrar en techo	MR16	No	GU10	1

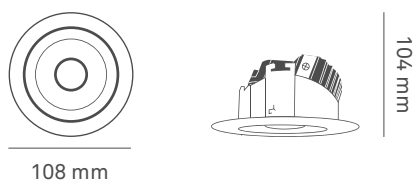

Carcasa cuadrada de empotrar móvil MR16 blanco

Código	Cuerpo	Terminado	Aplicaciones	Tipo de lámpara	Lámpara incluida	Base	Piezas
A1M-OS14S0-G-B3/00	Aluminio	Blanco	Empotrar en techo	MR16	No	GU10	1

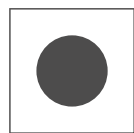

83 mm

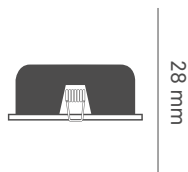

28 mm



Carcasa cuadrada de empotrar fijo MR16 blanco

Código	Cuerpo	Terminado	Aplicaciones	Tipo de lámpara	Lámpara incluida	Base	Piezas
A1F-OS14S0-G-B5/00	Aluminio	Blanco	Empotrar en techo	MR16	No	GU10	1

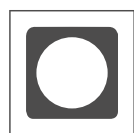

100 mm

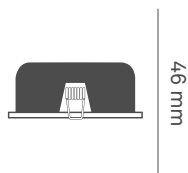

46 mm

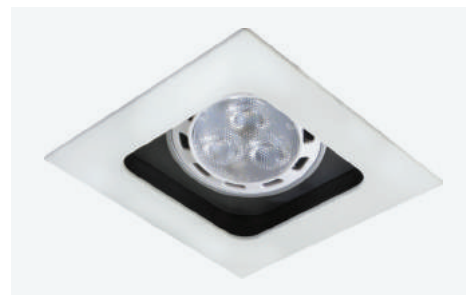

Carcasa cuadrada de empotrar fijo MR16 gris

Código	Cuerpo	Terminado	Aplicaciones	Tipo de lámpara	lámpara incluida	Base	Piezas
A1F-0S3S0-G-G5/00	Aluminio	Gris	Empotrar en techo	MR16	No	GU10	1



90 mm



145 mm

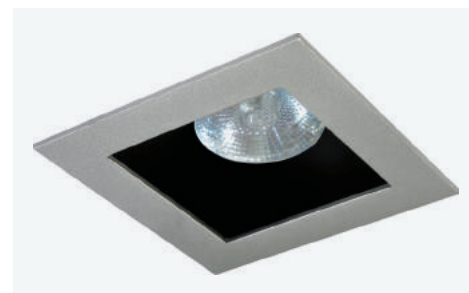

Carcasa cuadrada de empotrar fijo MR16 blanco

Código	Cuerpo	Terminado	Aplicaciones	Tipo de lámpara	Lámpara incluida	Base	Piezas
A1F-0S3S0-G-B4/00	Aluminio	Blanco	Empotrar en techo	MR16	No	GU10	1

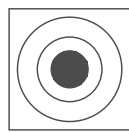

120 mm

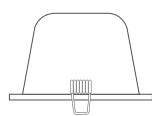

105 mm



Carcasa cuadrada de empotrar 1, 2, 3 y 4 salidas GU10 blanco

Código	Cuerpo	Terminado	Aplicaciones	Tipo de lámpara	Lámpara incluida	Base	Piezas
A1F-0S7S0-G-B3/00	Aluminio	Blanco	Empotrar en techo	MR16	No	GU10	1
A1F-0S7S0-G-B3/02	Aluminio	Blanco	Empotrar en techo	MR16	No	GU10	1
A1F-0S7S0-G-B3/03	Aluminio	Blanco	Empotrar en techo	MR16	No	GU10	1
A1F-0S7S0-G-B3/04	Aluminio	Blanco	Empotrar en techo	MR16	No	GU10	1

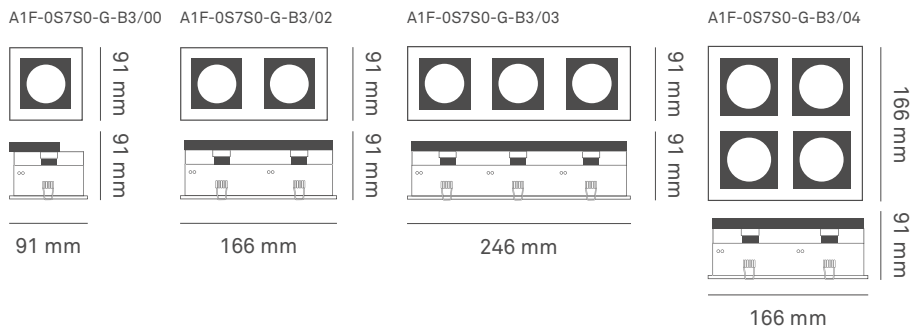

Carcasa cuadrada de empotrar dirigible 1, 2 y 3 salidas AR111 negro

Código	Cuerpo	Terminado	Aplicaciones	Tipo de lámpara	Lámpara incluida	Base	Piezas
A1D-0S12S0-G-N3/00	Aluminio	Negro	Empotrar en techo	AR111	No	G53	1
A1D-0S12S0-G-N3/02	Aluminio	Negro	Empotrar en techo	AR111	No	G53	1
A1D-0S12S0-G-N3/03	Aluminio	Negro	Empotrar en techo	AR111	No	G53	1

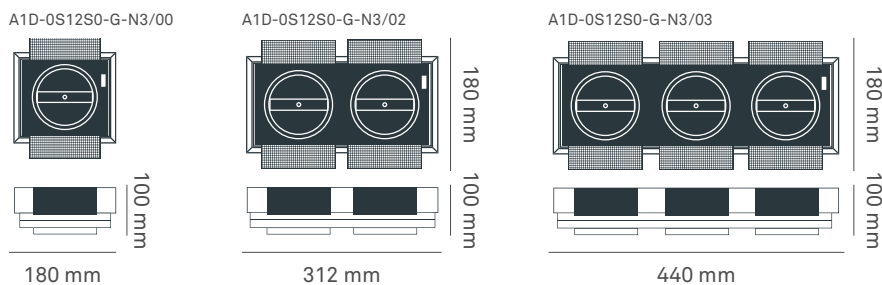

Carcasa de suspender 2, 3 y 4 lámparas AR111 blanco

Código	Cuerpo	Terminado	Aplicaciones	Tipo de lámpara	Lámpara incluida	Base	Piezas
A3M-0S12S0-G-G6/00	Aluminio	Blanco	Suspender en techo	AR111	No	G53	1
A3M-0S12S0-G-G6/01	Aluminio	Blanco	Suspender en techo	AR111	No	G53	1
A3M-0S12S0-G-G6/02	Aluminio	Blanco	Suspender en techo	AR111	No	G53	1

A3M-0S12S0-G-G6/00

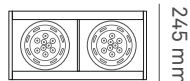

308 mm

245 mm

A3M-0S12S0-G-G6/01

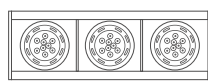

475 mm

245 mm

A3M-0S12S0-G-G6/02

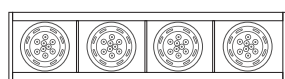

626 mm

245 mm



Carcasa cuadrada de empotrar dirigible 1, 2, 3 y 4 salidas CDMT gris

Código	Cuerpo	Terminado	Aplicaciones	Tipo de lámpara	Lámpara incluida	Base	Piezas
A1D-0S4S0-G-G3/00	Aluminio	Gris	Empotrar en techo	CDMT	No	G12	1
A1D-0S4S0-G-G3/02	Aluminio	Gris	Empotrar en techo	CDMT	No	G12	1
A1D-0S4S0-G-G3/03	Aluminio	Gris	Empotrar en techo	CDMT	No	G12	1
A1D-0S4S0-G-G3/04	Aluminio	Gris	Empotrar en techo	CDMT	No	G12	1

A1D-0S4S0-G-G3/00



186 mm

156 mm

202 mm

A1D-0S4S0-G-G3/02



186 mm

354 mm

202 mm

A1D-0S4S0-G-G3/03



186 mm

527 mm

202 mm

A1D-0S4S0-G-G3/04



355 mm

355 mm

202 mm



Carcasa cuadrada de empotrar fijo 1 lámpara HQI 70 W blanco

Código	Cuerpo	Terminado	Aplicaciones	Tipo de lámpara	Lámpara incluida	Base	Piezas
A1F-0S15S0-G-B3/01	Aluminio	Blanco	Empotrar en techo	HQI	No	RX75	1

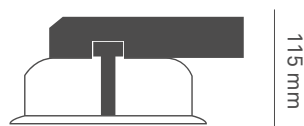
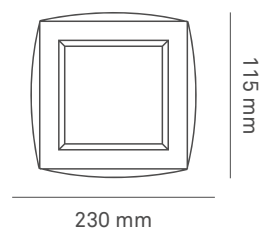

Carcasa esférica de sobreponer dirigible AR111 blanco

Código	Cuerpo	Terminado	Aplicaciones	Tipo de lámpara	Lámpara incluida	Base	Piezas
A4F-0S12S0-G-B8/00	Aluminio	Blanco	Sobreponer en techo	AR111	No	G53	1

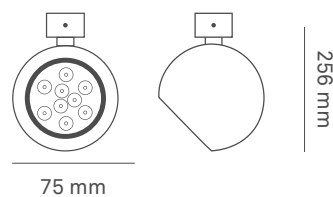



Carcasa de empotrar a muro halógena G9 blanco

Código	Cuerpo	Terminado	Aplicaciones	Tipo de lámpara	Lámpara incluida	Base	Piezas
A5M-0S6S0-8-B0/00	Aluminio	Blanco	Empotrar a muro	Halógena	No	G9	1

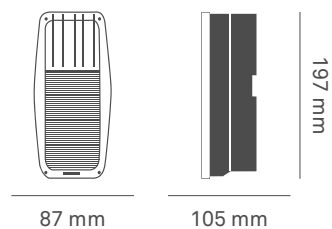

Carcasa para sobreponer en riel PAR blanco

Código	Cuerpo	Terminado	Aplicaciones	Tipo de lámpara	Lámpara incluida	Base	Piezas
A7M-0S1S0-G-B0/00	Aluminio	Blanco	Sobreponer a riel	PAR20	No	E-26	1
A7M-0S1S0-G-B0/01	Aluminio	Blanco	Sobreponer a riel	PAR30	No	E-26	1
A7M-0S1S0-G-B0/02	Aluminio	Blanco	Sobreponer a riel	PAR38	No	E-26	1

A7M-0S1S0-G-B0/01

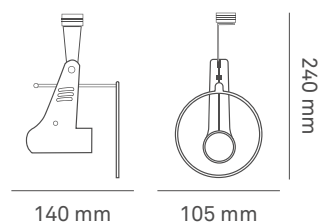

A7M-0S1S0-G-B0/02

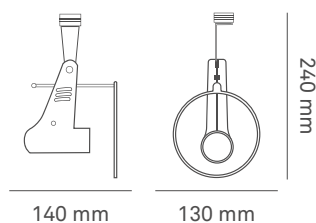

Luminario cuadrado de empotrar VR de LED con 2 lámparas PLC blanco

Código	W	V	Hz	K	Base	Ángulo	lm	Piezas
A1F-2L9S41-F-B4/111	22	120-277	50/60	4 100	G24q3	75°-45°	2 300	1

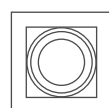
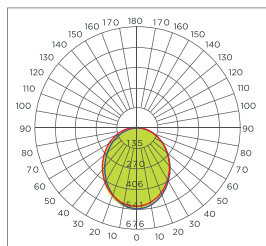

240 mm

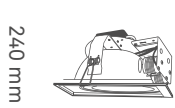

152 mm

240 mm



Carcasa

Código	Cuerpo	Terminado	Aplicaciones	Tipo de lámpara	Lámpara incluida	Base	Piezas
A1F-0S9S0-G-B4/01	Aluminio	Blanco	Empotrar en techo	PLC	No	G24q3	1

Luminario cuadrado de empotrar VC de LED con 2 lámparas PLC blanco

Código	W	V	Hz	K	Base	Ángulo	lm	Piezas
A1F-2L9S41-F-B3/111	22	120-277	50/60	4 100	G24q3	75°	2 300	1

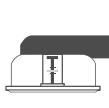
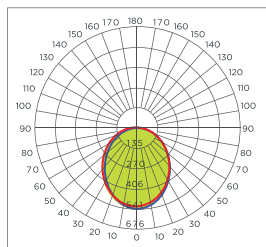

230 mm



230 mm

230 mm



Carcasa

Código	Cuerpo	Terminado	Aplicaciones	Tipo de lámpara	Lámpara incluida	Base	Piezas
A1F-0S9S0-G-B3/01	Aluminio	Blanco	Empotrar en techo	PLC	No	G24q3	1

Luminario cuadrado de empotrar CU de LED con 2 lámparas PLC blanco

Código	W	V	Hz	K	Base	Ángulo	lm	Piezas
A1F-2L9S41-F-B3/112	22	120-277	50/60	4 100	G24q3	75°	2 300	1

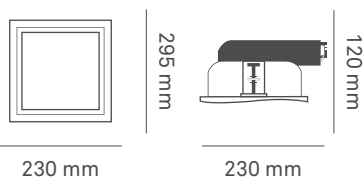
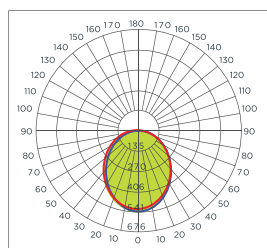
NOM

LED

Carcasa

Código	Cuerpo	Terminado	Aplicaciones	Tipo de lámpara	Lámpara incluida	Base	Piezas
A1F-0S9S0-G-B3/02	Aluminio	Blanco	Empotrar en techo	PLC	No	G24q3	1

Luminario cuadrado de empotrar CR de LED con 2 lámparas PLC blanco

Código	W	V	Hz	K	Base	Ángulo	lm	Piezas
A1F-2L9S41-F-B3/113	22	120-277	50/60	4 100	G24q3	60°	2 300	1

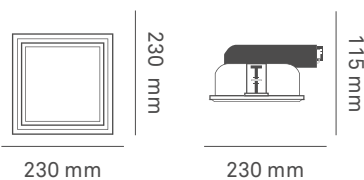
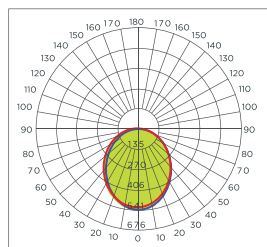
NOM

LED

Carcasa

Código	Cuerpo	Terminado	Aplicaciones	Tipo de lámpara	Lámpara incluida	Base	Piezas
A1F-0S9S0-G-B3/03	Aluminio	Blanco	Empotrar en techo	PLC	No	G24q3	1

Luminario cuadrado de empotrar RA de LED con 2 lámparas PLC blanco

Código	W	V	Hz	K	Base	Ángulo	lm	Piezas
A1F-2L9S41-F-B5/111	22	120-277	50/60	4 100	G24q3	60°	2 300	1

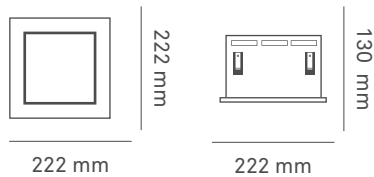
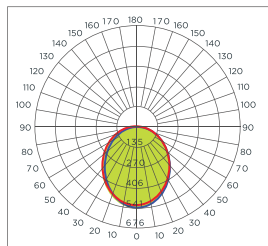

Carcasa

Código	Cuerpo	Terminado	Aplicaciones	Tipo de lámpara	Lámpara incluida	Base	Piezas
A1F-0S9S0-G-B5/01	Aluminio	Blanco	Empotrar en techo	PLC	No	G24q3	1

Luminario cuadrado de empotrar LI de LED con 2 lámparas PLC Blanco

Código	W	V	Hz	K	Base	Ángulo	lm	Piezas
A1F-2L9S41-F-B3/110	22	120-277	60	4 100	G24q3	75°	2 300	1

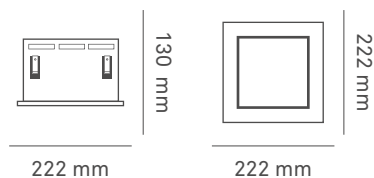
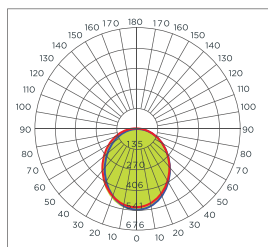

Carcasa

Código	Cuerpo	Terminado	Aplicaciones	Tipo de lámpara	Lámpara incluida	Base	Piezas
A1F-0S9S0-G-B3/00	Aluminio	Blanco	Empotrar en techo	PLC	No	G24q3	1



Luminario cuadrado de sobreponer de LED con 2 lámparas PLC blanco

Código	W	V	Hz	K	Base	Ángulo	lm	Piezas
A4F-2L9S41-F-B3/110	22	120-277	50/60	4 100	G24q3	75°-65°	2 300	1

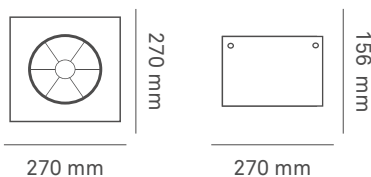
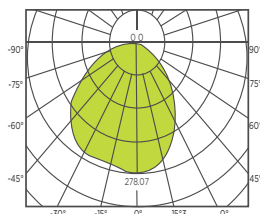

Carcasa

Código	Cuerpo	Terminado	Aplicaciones	Tipo de lámpara	Lámpara incluida	Base	Piezas
A4F-0S10S0-G-B3/00	Aluminio	Blanco	Sobreponer en techo	PLC	No	G24q3	1

Luminario circular de empotrar VE de LED con 2 lámparas PLC blanco

Código	W	V	Hz	K	Base	Ángulo	lm	Piezas
A1F-2L9S27-F-B1/110	22	120-277	50/60	4 100	G24q3	75°	2 300	1

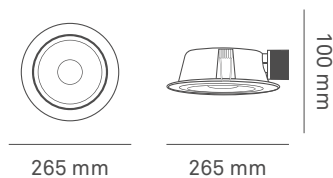
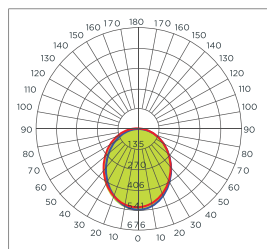

Carcasa

Código	Cuerpo	Terminado	Aplicaciones	Tipo de lámpara	Lámpara incluida	Base	Piezas
A1F-0S9S0-G-B1/00	Aluminio	Satinado	Empotrar en techo	PLC	No	G24q3	1

Luminario circular de empotrar LV de LED con 2 lámparas PLC blanco

Código	W	V	Hz	K	Base	Ángulo	lm	Piezas
A1F-2L9S27-F-B1/111	22	120-277	50/60	4 100	G24q3	75°	2 300	1

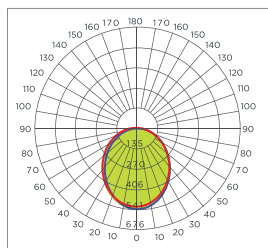

195 mm



195 mm

128 mm



Carcasa

Código	Cuerpo	Terminado	Aplicaciones	Tipo de lámpara	Lámpara incluida	Base	Piezas
A1F-0S9S0-G-B1/01	Aluminio	Blanco	Empotrar en techo	PLC	No	G24q3	1

Luminario circular de empotrar VL de LED con 2 lámparas PLC blanco

Código	W	V	Hz	K	Base	Ángulo	lm	Piezas
A1F-2L9S27-F-B1/112	22	120-277	50/60	4 100	G24q3	75°	2 300	1

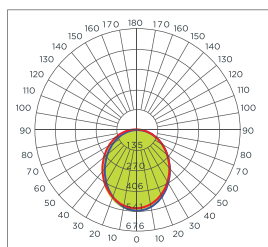

270 mm

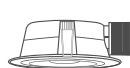

270 mm

100 mm



Carcasa

Código	Cuerpo	Terminado	Aplicaciones	Tipo de lámpara	Lámpara incluida	Base	Piezas
A1F-0S9S0-G-B1/02	Aluminio	Blanco	Empotrar en techo	PLC	No	G24q3	1

Luminario circular de sobreponer de LED con 2 lámparas PLC blanco

Código	W	V	Hz	K	Base	Ángulo	lm	Piezas
A4F-2L10S41-F-B1/110	22	120-277	50/60	4 100	G24q3	75°	2 300	1

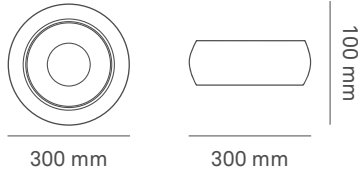
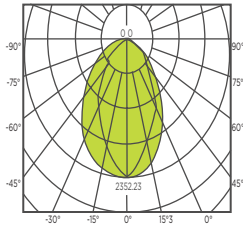

Carcasa

Código	Cuerpo	Terminado	Aplicaciones	Tipo de lámpara	Lámpara incluida	Base	Piezas
A4F-0S10S0-G-B1/00	Aluminio	Blanco	Sobreponer en techo	PLC	No	G24q3	1

Luminario cuadrado de empotrar de LED blanco

Código	W	V	Hz	K	lm	Vida	Piezas
						(horas)	
A1F-1L8S27-G-B2/200	20	120-240	60	4 100	1 440	35 000	1

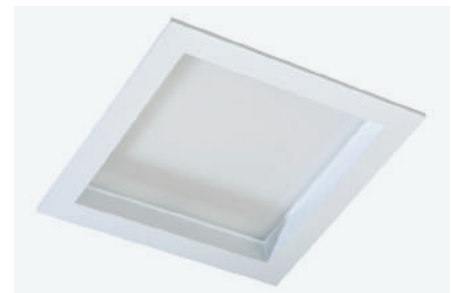
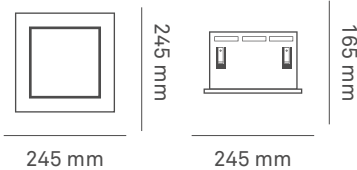
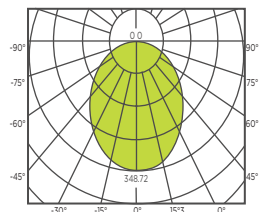

Luminario cuadrado de empotrar de LED dirigible blanco

Código	W	V	Hz	K	lm	Vida (horas)	Piezas
A1D-1L8S27-C-B3/60	6	120-240	60	2 700	480	35 000	1

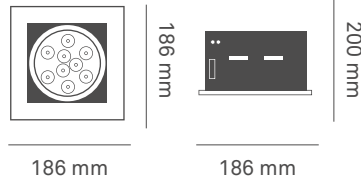
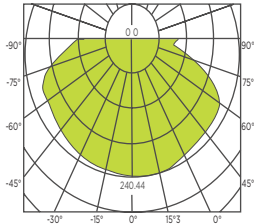

Luminario cuadrado de empotrar de LED con difusor tipo pirámide de acrílico blanco

Código	W	V	Hz	K	lm	Vida (horas)	Piezas
AFL104A	20	110-240	60	4 200	1 500	35 000	1

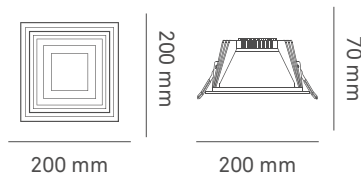
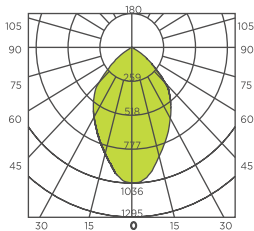

Luminario cuadrado de empotrar de LED 1 salida dirigible con reflector especular gris

Código	W	V	Hz	K	lm	Vida (horas)	Piezas
AF001ABL	25	120-240	60	4 200	2 120	35 000	1

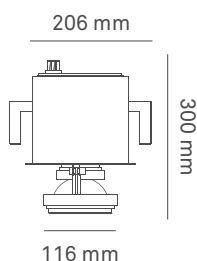
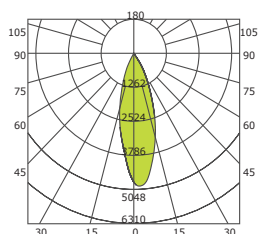

Luminario cuadrado de empotrar de LED 2 salidas dirigible con reflector especular gris

Código	W	V	Hz	K	lm	Vida (horas)	Piezas
AF002ABL	2x25	110-240	60	4 200	4 180	35 000	1

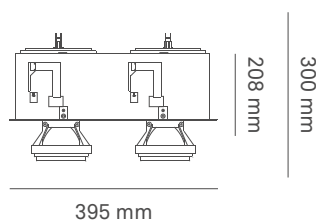
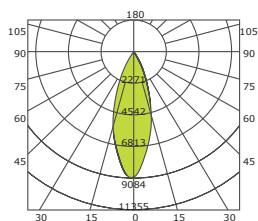

Luminario cuadrado de empotrar de LED 1 salida dirigida con reflector circular de acrílico blanco

Código	W	V	Hz	K	lm	Vida (horas)	Piezas
AFL100	10	110-240	60	3 000	870	35 000	1

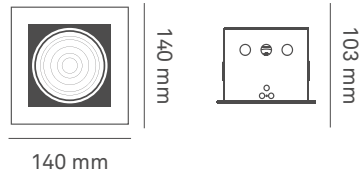
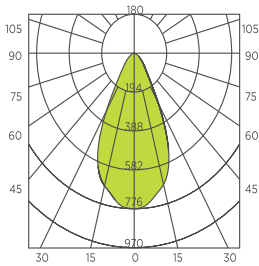

Luminario cuadrado de empotrar de LED 2 salidas dirigida con reflector circular de acrílico blanco

Código	W	V	Hz	K	lm	Vida (horas)	Piezas
AFL100-2	2x10	110-240	60	3 000	1 750	35 000	1

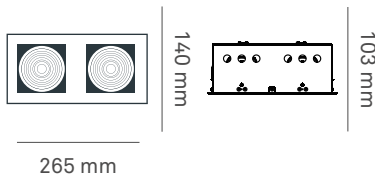
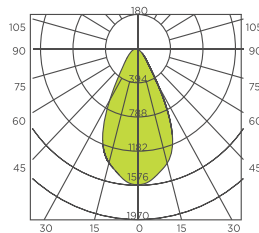

Luminario cuadrado de empotrar de LED 3 salidas dirigible de acrílico con reflector circular blanco

Código	W	V	Hz	K	lm	Vida (horas)	Piezas
AFL100-3	3x10	110-240	60	3 000	2 450	35 000	1

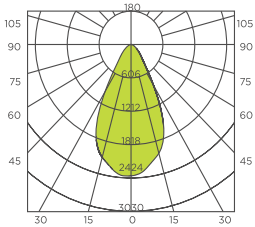

265 mm

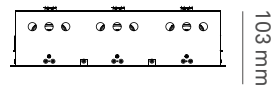

265 mm



Luminario cuadrado de empotrar de LED 4 salidas dirigible de acrílico con reflector circular blanco

Código	W	V	Hz	K	lm	Vida (horas)	Piezas
AFL100-4	4x10	110v240	60	3 000	3 280	35 000	1

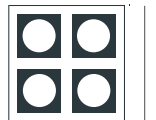
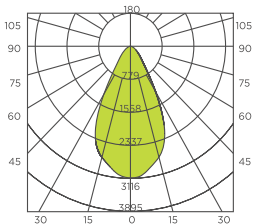

260 mm



260 mm



Luminario cuadrado de empotrar de LED 1 salida dirigida especular con reflector circular blanco

Código	W	V	Hz	K	lm	Vida (horas)	Piezas
AFL72A	6.5	110-240	60	3 000	525	35 000	1

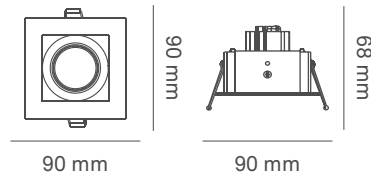
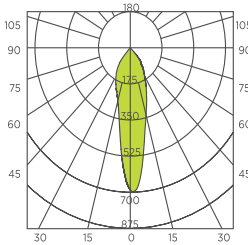

Luminario cuadrado de empotrar de LED 2 salidas dirigida especular con reflector circular blanco

Código	W	V	Hz	K	lm	Vida (horas)	Piezas
AFL72A-2	2x6.5	110-240	60	3 000	1 030	35 000	1

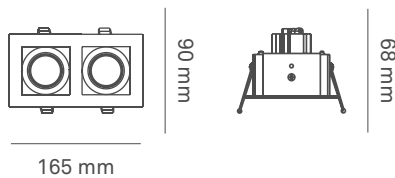
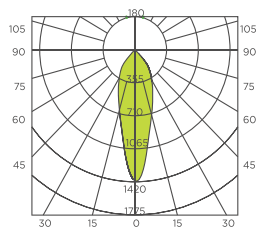

Luminario cuadrado de empotrar de LED 3 salidas dirigible especular con reflector circular blanco

Código	W	V	Hz	K	lm	Vida (horas)	Piezas
AFL72A-3	3x6.5	110-240	60	3 000	1 550	35 000	1

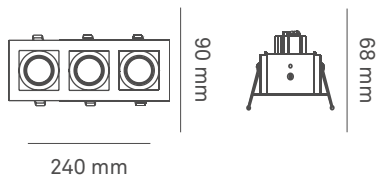
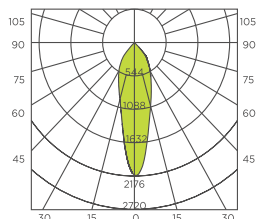

Luminario cuadrado de empotrar de LED 4 salidas dirigible especular con reflector circular blanco

Código	W	V	Hz	K	lm	Vida (horas)	Piezas
AFL72A-4	4x6.5	110-240	60	3 000	2 070	35 000	1

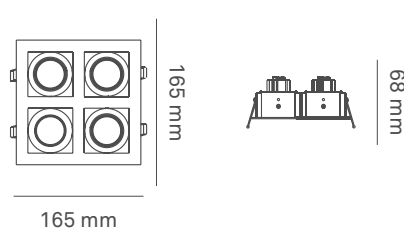
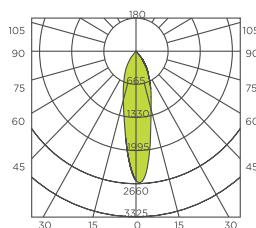

Luminario cuadrado de empotrar de LED 1 salida fijo especular con reflector cuadrado blanco

Código	W	V	Hz	K	lm	Vida (horas)	Piezas
AFL72B	10	110-240	60	3 000	840	35 000	1

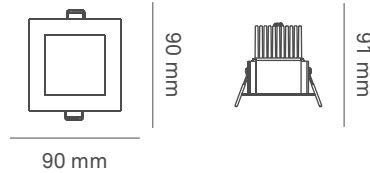
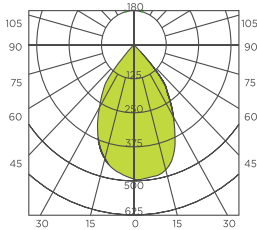
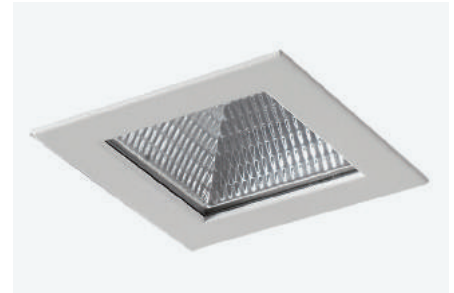

Luminario cuadrado de empotrar de LED 2 salidas fijo especular con reflector cuadrado blanco

Código	W	V	Hz	K	lm	Vida (horas)	Piezas
AFL72B-2	2x10	220-240	60	3 000	1 650	35 000	1

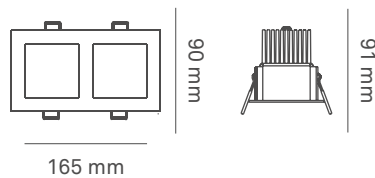
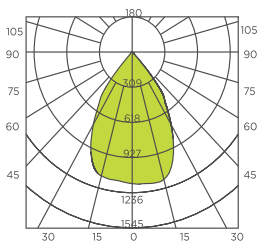

Luminario cuadrado de empotrar de LED 3 salidas fijo especular con reflector cuadrado blanco

Código	W	V	Hz	K	lm	Vida (horas)	Piezas
AFL72B-3	3x10	110-240	60	3 000	2 480	35 000	1

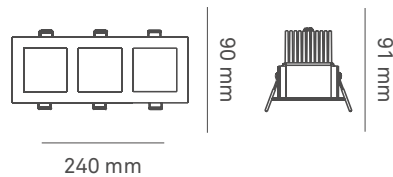
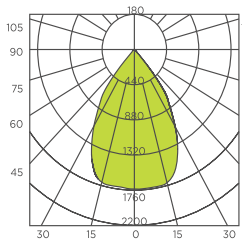

Luminario cuadrado de empotrar de LED 4 salidas fijo especular con reflector cuadrado blanco

Código	W	V	Hz	K	lm	Vida (horas)	Piezas
AFL72B-4	4x10	110-240	60	4 200	3 280	35 000	1

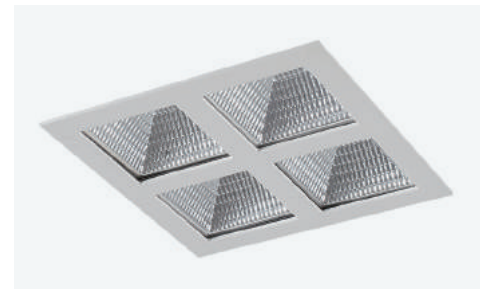
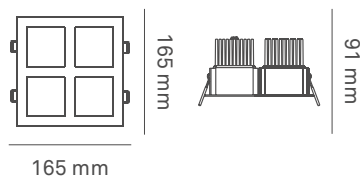
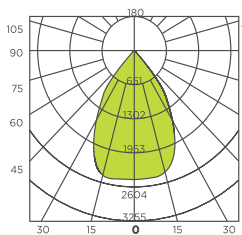

Luminario cuadrado de empotrar de LED con difusor cuadrado de acrílico blanco

Código	W	V	Hz	K	lm	Vida (horas)	Piezas
AF8031L	20	110-240	60	4 200	1 698	35 000	1

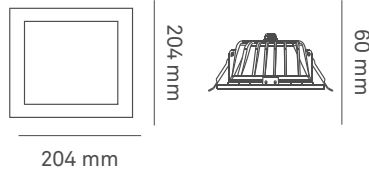
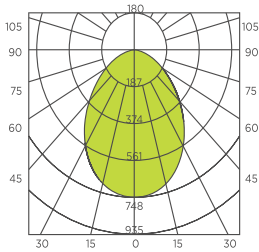

Luminario cuadrado de empotrar de LED con marco de cristal blanco

Código	W	V	Hz	K	lm	Vida (horas)	Piezas
AFL106A	12	110-240	60	3 000	810	35 000	1

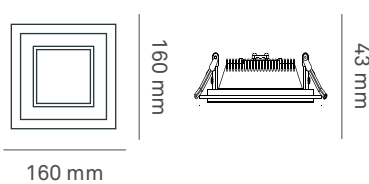
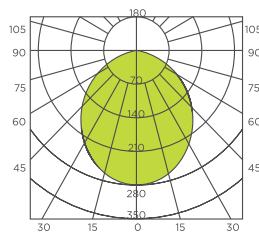

Luminario downlight de LED

Código	W	V	Hz	K	Dimensiones	lm	Vida	Piezas
					AxB (mm)			
9403150	9	100-240	60	3 000	82x43	800	30 000	1
9403165	12	100-240	60	3 000	125x62	1 100	30 000	1
9403170	18	100-240	60	4 000	190x84	1 400	30 000	1
9403175	23	100-240	60	4 000	230x81	1 600	30 000	1
9403180	36	100-240	60	4 000	230x81	3 200	30 000	1

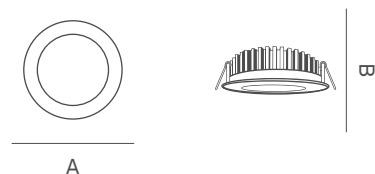

LED RoHS

Luminario downlight de LED con color de temperatura ajustable

Código	W	V	Hz	Dimensiones	lm	Vida	Piezas
				AxB (mm)			
9403162	10	100-277	60	110x37	800	30 000	1
9403177	25	100-277	60	230x82	2 000	30 000	1

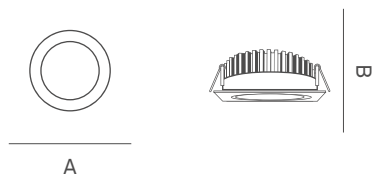

LED

Cálida Neutra Fría

Luminario downlight dirigible de LED

Código	W	V	Hz	K	lm	Vida (horas)	Piezas
9403155	9	100-240	60	3 000	800	30 000	1

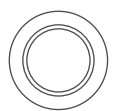

110 mm

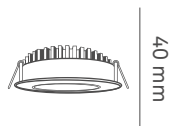

40 mm



Luminario circular de empotrar de LED fijo especular blanco

Código	W	V	Hz	K	lm	Vida (horas)	Piezas
A1F-1L8S27-G-B1/5.40	5.4	120-240	60	2 700	400	35 000	1

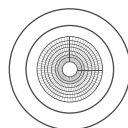
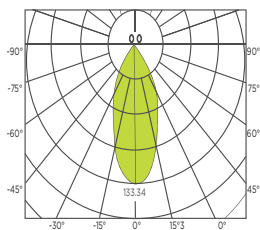

118 mm



90 mm



Luminario circular de empotrar de LED fijo especular blanco

Código	W	V	Hz	K	lm	Vida (horas)	Piezas
A1F-1L8S27-G-B2/5.40	5.4	120-240	60	2 700	410	35 000	1

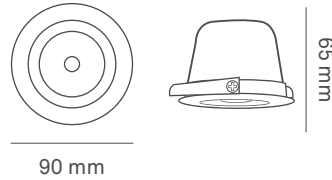
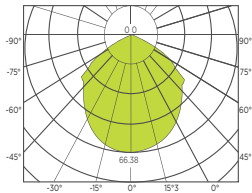

Luminario circular de empotrar de LED con pantalla de acrílico blanco

Código	W	V	Hz	K	lm	Vida (horas)	Piezas
AF3018YL	10	110-240	60	3 000	550	35 000	1
AF8018YL	20	110-240	60	4 200	1 180	35 000	1



AF3018YL

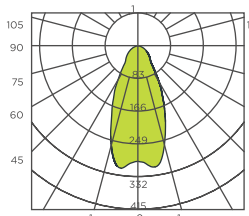

AF8018YL

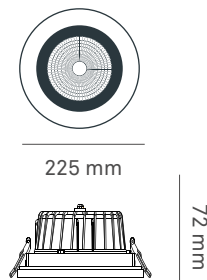
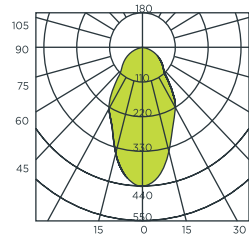

Luminario circular de empotrar de LED con reflector especular blanco

Código	W	V	Hz	K	lm	Vida (horas)	Piezas
AF5026LA	10	110-240	60	3 000	740	35 000	1

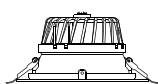
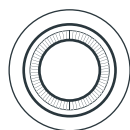
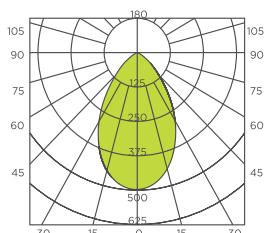

65 mm

180 mm



Luminario circular de empotrar de LED con reflector cónico especular blanco

Código	W	V	Hz	Dimensiones (mm)	K	lm	Vida (horas)	Piezas
AFL62A	10	110-240	60	131x70	3 000	830	35 000	1
AFL62B	15	120-240	60	162x74	4 200	1 140	35 000	1
AFL62C	20	110-240	60	190x80	4 200	1 605	35 000	1

AFL62A

AFL62B

AFL62C

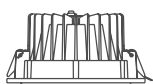
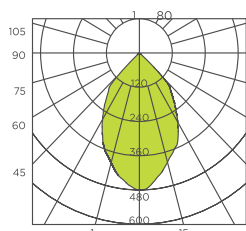
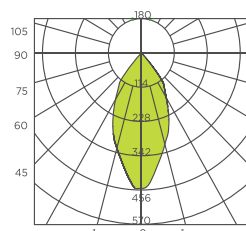
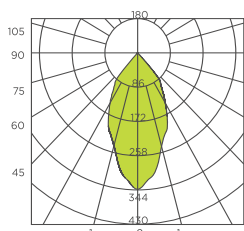

70

A



Luminario circular de empotrar de LED fijo de aluminio

Código	W	V	Hz	K	lm	Vida (horas)	Piezas
A1F-1L8S27-G-A1/2.50	2.5	120-240	60	2 700	200	35 000	1

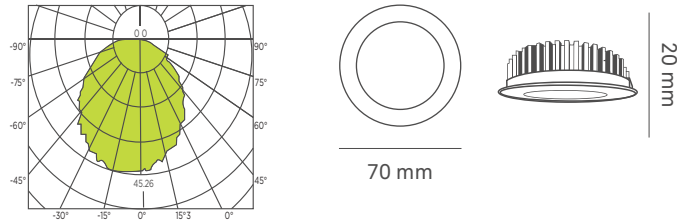

Luminario circular de empotrar de LED con difusor de acrílico blanco

Código	W	V	Hz	K	lm	Vida (horas)	Piezas
AF2040L	6	110-240	60	3 000	418	35 000	1

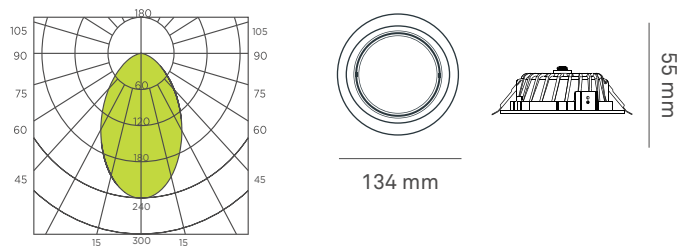

Luminario circular de empotrar de LED con difusor de acrílico blanco

Código	W	V	Hz	K	lm	Vida (horas)	Piezas
AFL77	45	110-240	60	4 200	3 670	35 000	1

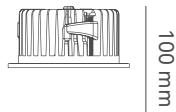
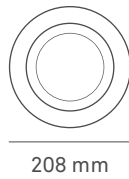
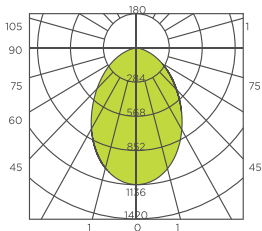

Luminario circular de empotrar de LED con difusor de acrílico blanco

Código	W	V	Hz	K	lm	Vida (horas)	Piezas
AFL88B	10	110-240	60	3 000	650	35 000	1

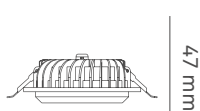
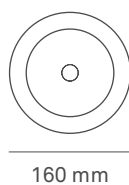
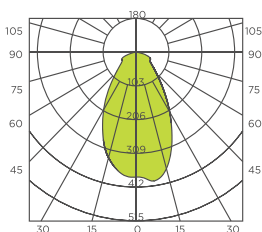

Luminario circular de empotrar de LED con marco de cristal blanco

Código	W	V	Hz	K	lm	Vida (horas)	Piezas
AFL105A	12	110-240	60	3 000	800	35 000	1

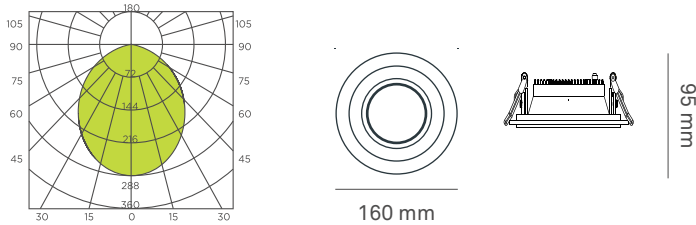
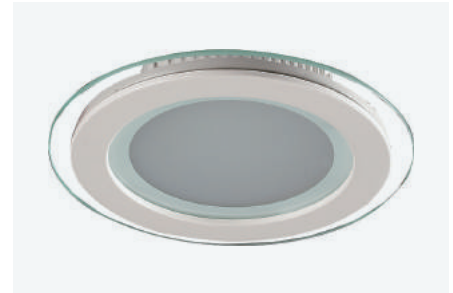

Luminario circular de empotrar de LED dirigible con reflector espejador blanco

Código	W	V	Hz	K	lm	Vida (horas)	Piezas
AFL90	6.5	110-240	60	3 000	550	35 000	1

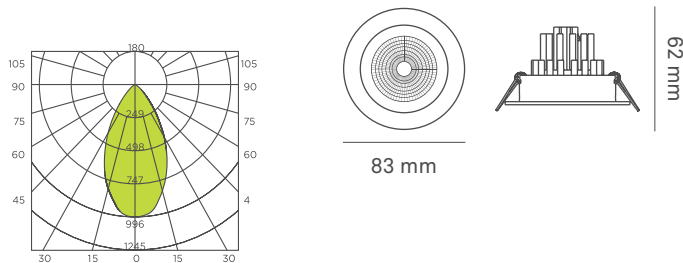

Luminario circular de empotrar de LED dirigible con reflector especular blanco

Código	W	V	Hz	K	lm	Vida (horas)	Piezas
AFL98A	10	110-240	60	3 000	850	35 000	1

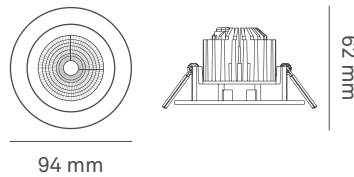
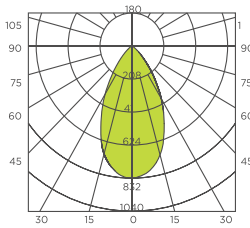

Luminario circular de empotrar de LED dirigible con reflector cónico especular blanco

Código	W	V	Hz	K	lm	Vida (horas)	Piezas
AF8063L	25	110-240	60	4 200	2 010	35 000	1

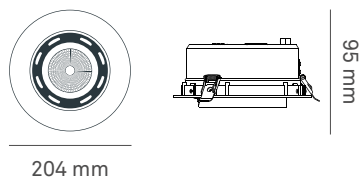
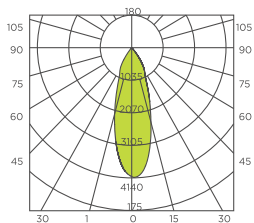

Luminario circular de empotrar de LED dirigible blanco

Código	W	V	Hz	K	lm	Vida (horas)	Piezas
A1D-1L8S27-G-A1/30	3	120-240	60	2 700	240	35 000	1

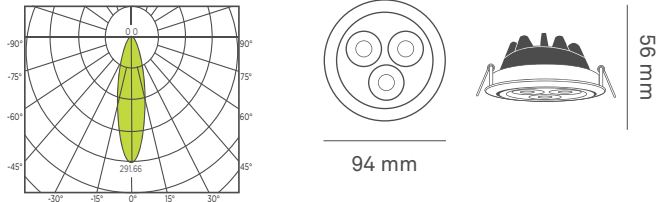

Luminario circular de empotrar de LED dirigible con reflector cónico especcular blanco

Código	W	V	Hz	K	lm	Vida (horas)	Piezas
AFL76	6.5	110-240	60	3 000	530	35 000	1

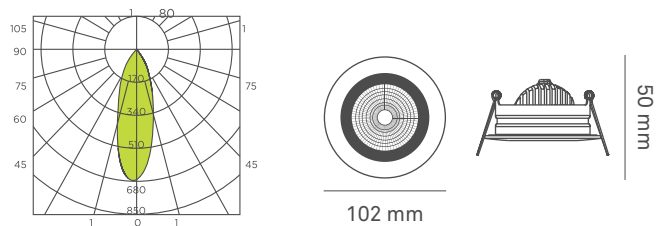

Luminario circular de sobreponer de LED con difusor de acrílico blanco

Código	W	V	Hz	K	lm	Vida (horas)	Piezas
A4F-1L8S27-C-B1/200	20	120-240	60	3 000	1 440	35 000	1

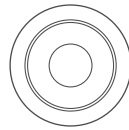
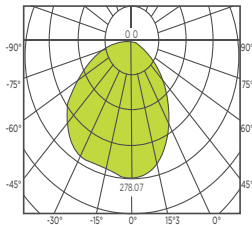

450 mm

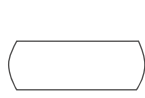

128 mm



Luminario circular de sobreponer de LED con acrílico circular blanco

Código	W	V	Hz	K	lm	Vida (horas)	Piezas
AFL78C	20	110-240	60	4 200	1 635	35 000	1

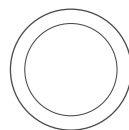
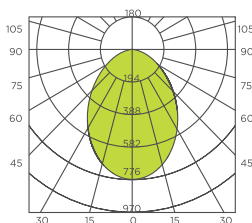

305 mm

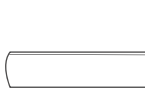

100 mm



Luminario circular de sobreponer de LED con difusor de acrílico blanco

Código	W	V	Hz	K	lm	Vida (horas)	Piezas
AFL78	30	110-240	60	4 200	2 040	35 000	1

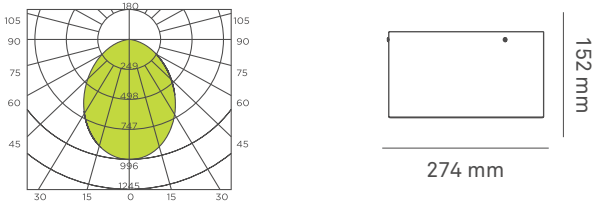

Luminario circular de sobreponer de LED con difusor de acrílico blanco

Código	W	V	Hz	K	lm	Vida (horas)	Piezas
AFL78A	15	110-240	60	4 200	1 027	35 000	1

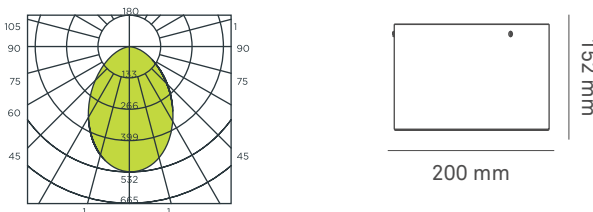

Luminario circular de sobreponer de LED con reflector de acrílico blanco

Código	W	V	Hz	K	lm	Vida (horas)	Piezas
AF9009BL	10	110-240	60	3 000	850	35 000	1

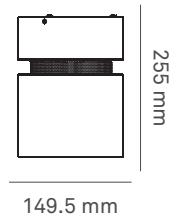
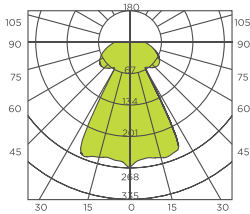

Luminario circular de sobreponer a techo de LED con difusor de acrílico negro

Código	W	V	Hz	K	lm	Vida (horas)	Piezas
AFWL103L	15	110-240	60	3 000	530	35 000	1

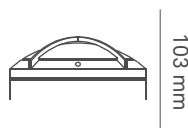
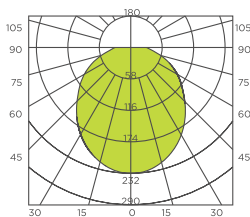

Plafón cuadrado liso de LED

Código	W	V	Hz	K	lm	Vida (horas)	Piezas
9403255	12	100-240	60	6 400	840	30 000	1

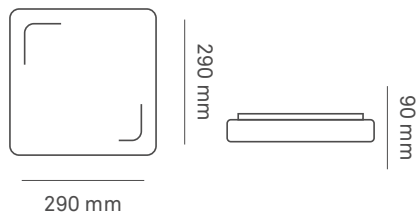

Plafón circular liso de LED

Código	W	V	Hz	K	lm	Vida (horas)	Piezas
9403250	12	100-240	60	6 400	840	30 000	1

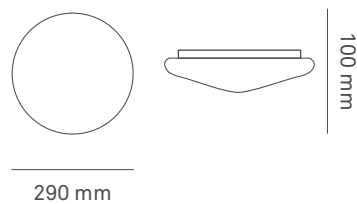

Plafón decorativo con filo de aluminio de LED

Código	W	V	Hz	K	Ángulo	lm	Vida (horas)	Piezas
9403257	14	127	60	3 000	120°	1 000	25 000	1

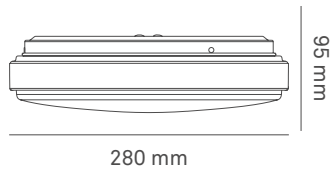

Lámpara de techo con casquillo de LED

Código	W	V	Hz	K	Dimensiones AxB (mm)	Base	lm	Vida (horas)	Piezas
9403192	10	120-240	60	6 500	Ø 178x85	E-26	800	15 000	10
9403198	16	120-240	60	6 500	Ø 200x100	E-26	1 300	15 000	8

- Es atornillable.

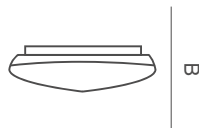
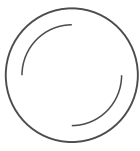

Luminario tipo cubo de suspender de LED

Código	W	V	Hz	K	lm	Vida (horas)	Piezas
AFL81	15	110-240	60	4 200	1 070	35 000	1

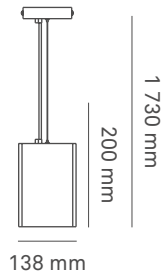
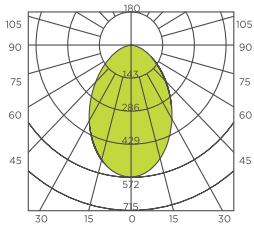

Luminario circular de suspender de LED con difusor de acrílico blanco

Código	W	V	Hz	K	lm	Vida (horas)	Piezas
A3M-1L8S27-C-B1/200	20	120 -240	60	3 000	1 440	35 000	1

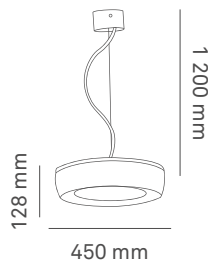
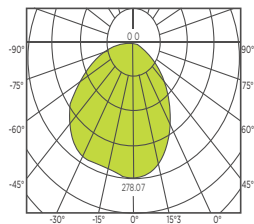

Luminario tipo cono de suspender de LED

Código	W	V	Hz	K	lm	Vida (horas)	Piezas
AF44L	20	110-240	60	4 200	1 440	35 000	1

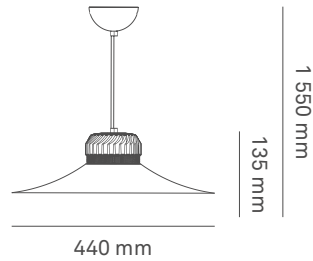
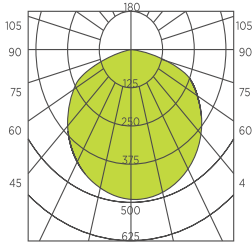

Luminario tipo cono de suspender de LED

Código	W	V	Hz	K	lm	Vida (horas)	Piezas
AF36BL	20	110-240	60	4 200	1 305	35 000	1

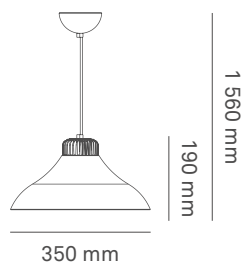
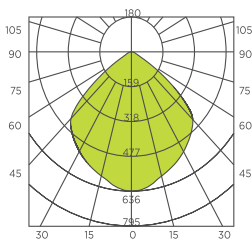

Luminario tipo campana de suspender de LED

Código	W	V	Hz	K	lm	Vida (horas)	Piezas
AF30BL	35	110-240	60	4 200	2 650	35 000	1

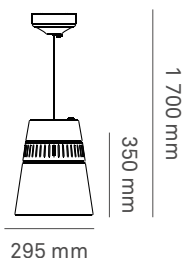
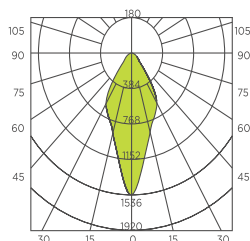

Luminario tipo campana de suspender de LED

Código	W	V	Hz	K	lm	Vida (horas)	Piezas
AF12JL	30	110-240	60	4 200	2 340	35 000	1

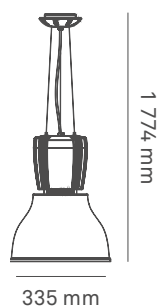
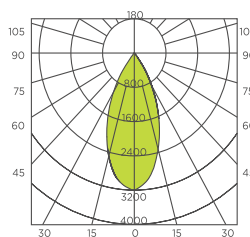

Luminario tipo campana de suspender de LED

Código	W	V	Hz	K	lm	Vida (horas)	Piezas
AF12CL	30	110-240	60	4 200	2 350	35 000	1

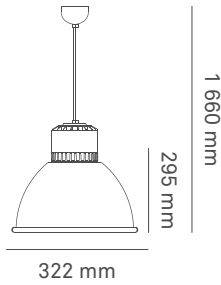
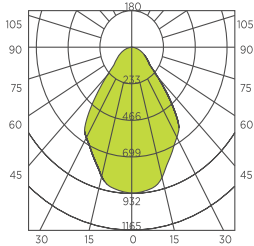

Luminario colgante de LED

Código	Color	W	V	Hz	K	Base	lm	Vida (horas)	Piezas
9403191	●	18	120-240	60	4 100	E-26	1 200	25 000	6
9403193	○	18	120-240	60	4 100	E-26	1 200	25 000	6
9403194	●	18	120-240	60	4 100	E-26	1 200	25 000	6
9403195	●	18	120-240	60	4 100	E-26	1 200	25 000	6
9403196	●	18	120-240	60	4 100	E-26	1 200	25 000	6
9403197	●	18	120-240	60	4 100	E-26	1 200	25 000	6

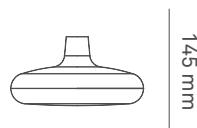
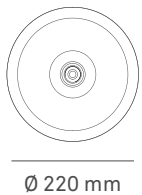

Luminario rectangular de sobreponer en riel de LED blanco

Código	W	V	Hz	K	lm	Vida (horas)	Piezas
A7M-1L8S27-C-B0/80	8	120-240	60	2 700	580	35 000	1

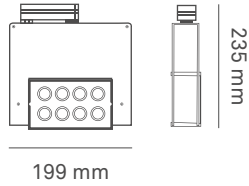
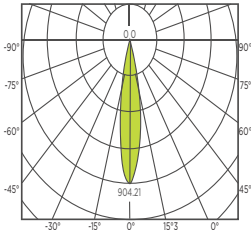

Luminario circular de sobreponer en riel de LED blanco

Código	W	V	Hz	K	lm	Vida (horas)	Piezas
A7M-1L8S27-C-B0/90	9	120-240	60	2 700	600	35 000	1

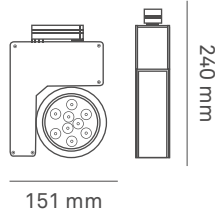
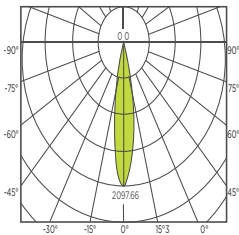

Luminario circular de sobreponer en riel de LED blanco

Código	W	V	Hz	K	lm	Vida (horas)	Piezas
A7M-1L8S27-C-B0/60	6	120-240	60	2 700	440	35 000	1

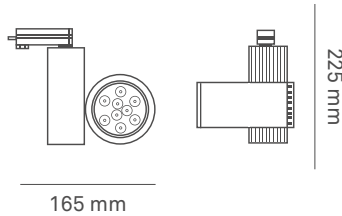
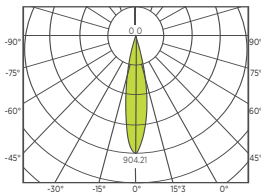

Luminario circular de sobreponer en riel de LED con reflector cónico especular blanco

Código	W	V	Hz	K	lm	Vida (horas)	Piezas
A7M-1L8S27-C-B0/230	23	120-240	60	2 700	1 610	35 000	1

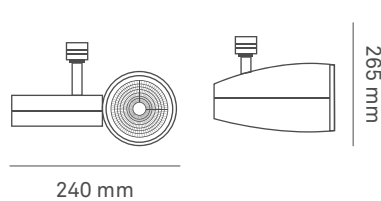
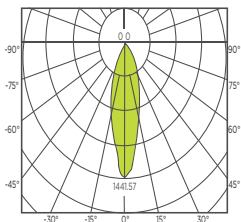

Luminario circular de sobreponer en riel de LED con reflector cónico especular blanco

Código	W	V	Hz	K	lm	Vida (horas)	Piezas
AFST122BL	25	110-240	60	4 200	2 010	35 000	1

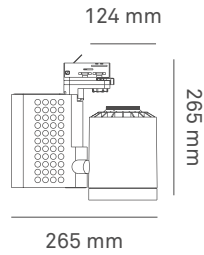
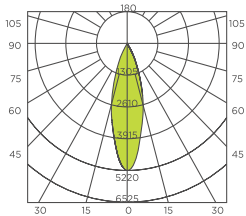

Luminario circular de sobreponer en riel de LED con reflector cónico especular blanco

Código	W	V	Hz	K	lm	Vida (horas)	Piezas
AFST135L	35	120-240	60	4 200	3 219	35 000	1

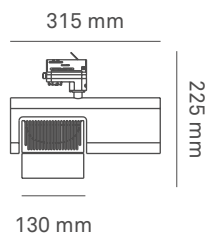
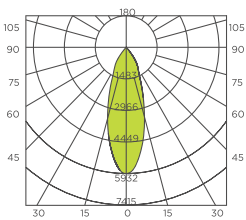

Luminario circular de sobreponer en riel de LED con reflector cónico especular blanco

Código	W	V	Hz	K	lm	Vida (horas)	Piezas
AFST136CL	35	110-240	60	4 200	2 780	35 000	1

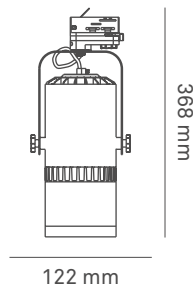
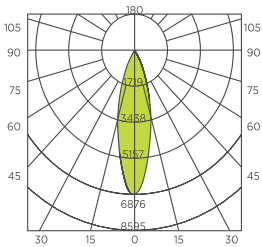

Luminario circular de sobreponer en riel de LED con reflector cónico especular blanco

Código	W	V	Hz	K	lm	Vida (horas)	Piezas
AFST144L	2x25	110-240	60	4 200	4 005	35 000	1

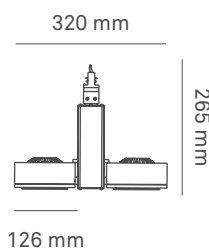
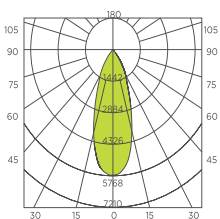

Riel para luminario

Código	W	V	Hz	A	No. de Hilos	Longitud	Piezas
	máx.					(m)	
RIEL3FX1M	2 000	127	60	10	3	1	1
RIEL3FX2M	2 000	127	60	10	3	2	1
RIEL4FX1M	3 900	127-220	60	15	4	1	1
RIEL4FX2M	3 900	127-220	60	15	4	2	1



Conectores para riel 4 hilos

Código	Descripción	Piezas
CONNECT4FI	Conector para Riel "I"	1
CONNECT4FL	Conector para Riel "L"	1
CONNECT4FT	Conector para Riel "T"	1
CONNECT4FX	Conector para Riel "X"	1



Luminario rectangular de sobreponer a muro de LED blanco

Código	W	V	Hz	K	lm	Vida (horas)	Piezas
AFWL171	5	110-240	60	3 000	355	35 000	1

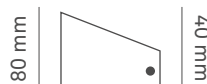
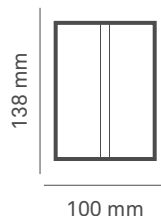
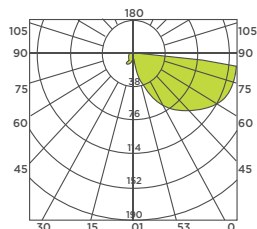
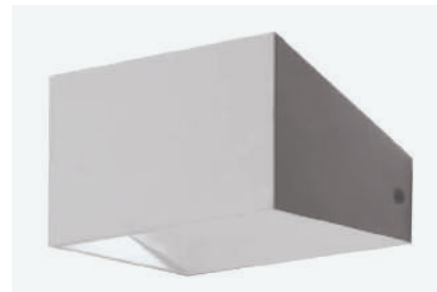

Luminario rectangular de sobreponer a muro de LED negro

Código	W	V	Hz	K	lm	Vida (horas)	Piezas
AFWL163	3.3	110-240	60	3 000	230	35 000	1

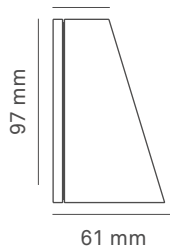
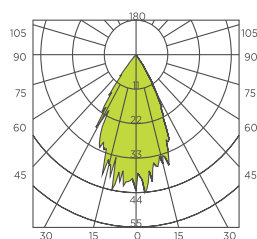

Luminario circular de sobreponer a muro de LED inclinado negro

Código	W	V	Hz	K	lm	Vida (horas)	Piezas
AFWL162	3.3	110-240	60	3 000	210	35 000	1

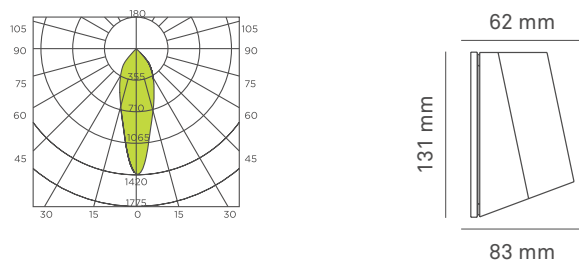
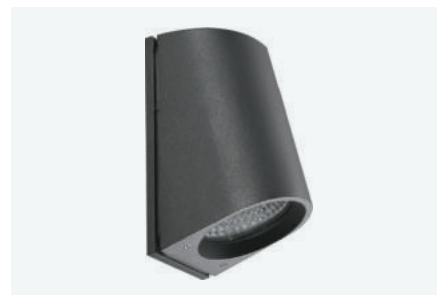

Luminario circular de sobreponer a muro de LED 2 salidas negro

Código	W	V	Hz	K	lm	Vida (horas)	Piezas
AFWL164	2x3.3	110-240	60	3 000	480	35 000	1

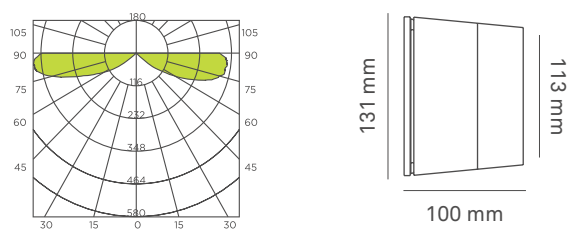

Luminario circular de sobreponer a muro de LED dirigible gris

Código	W	V	Hz	K	lm	Vida (horas)	Piezas
AF8028L	12	127-240	60	4 200	780	35 000	1

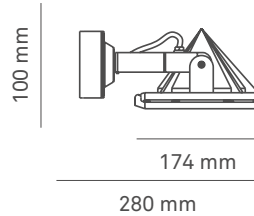
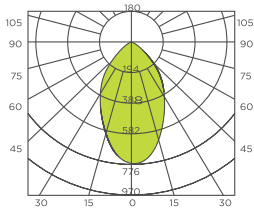

Luminario cuadrado de sobreponer a muro de LED exterior dirigible blanco

Código	W	V	Hz	K	lm	Vida (horas)	Piezas
A5M-1L8S27-C-B0/150	15	120-240	60	2 700	1 200	35 000	1

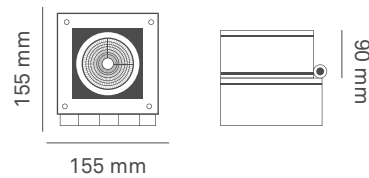
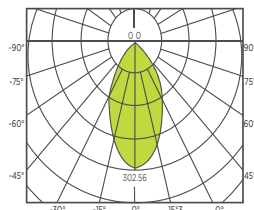

Luminario tipo pirámide de sobreponer a muro de LED blanco

Código	W	V	Hz	K	lm	Vida (horas)	Piezas
AFWL169	9	110-240	60	3 000	840	35 000	1

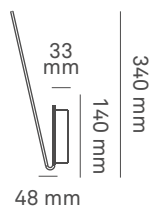
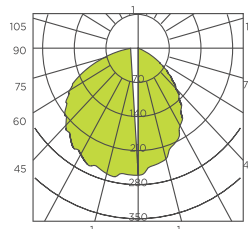

Farol clásico

Código	Color	Descripción	W	V	Hz	Base	Piezas
9400420	●	Farol de pared clásico	100	127	60	E-26	1
9400421	○	Farol de pared clásico	100	127	60	E-26	1



Características

- Material: aluminio inyectado.
- Terminado: pintura color negro o blanco.
- Pantalla: cristal transparente.

Farol colonial

Código	Color	Descripción	W	V	Hz	Base	Piezas
9400425	●	Farol de pared colonial	100	127	60	E-26	1
9400426	○	Farol de pared colonial	100	127	60	E-26	1

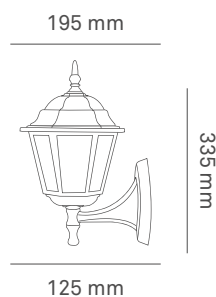

Características

- Material: aluminio inyectado.
- Terminado: pintura color negro o blanco.
- Pantalla: cristal transparente.

Luminario cuadrado de empotrar a piso de aluminio

Código	W	V	Hz	K	Dimensiones	lm	Vida	Piezas
					AxB (mm)			
9403061	5	100-277	60	3 000	120x68	500	35 000	1
9403065	12	100-277	60	3 000	160x58	1 200	35 000	1

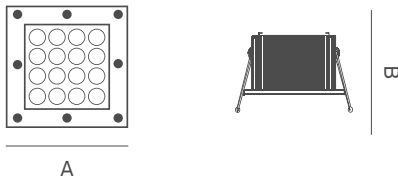
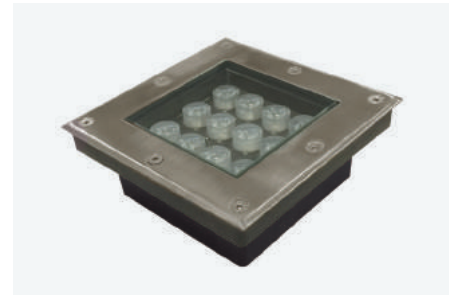

Luminario circular de empotrar a piso de aluminio

Código	W	V	Hz	K	Dimensiones	lm	Vida	Piezas
					Ø AxB (mm)			
9403051	6	100-277	60	3 000	Ø 150x90	600	35 000	1
9403056	12	100-277	60	3 000	Ø 180x90	1 200	35 000	1

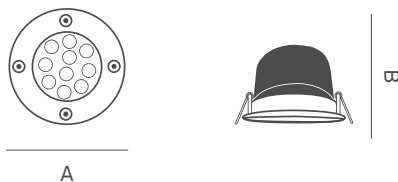

Lámpara de seguridad ahorradora

Código	Descripción	W	V	Hz	Dimensiones	Piezas
					AxBxC (mm)	
9401050	Lámpara ahorradora	65	127	60	290x270x107	1
9401150	Lámpara ahorradora	85	127	60	305x340x240	1
9401200	Lámpara ahorradora	105	127	60	305x340x240	1

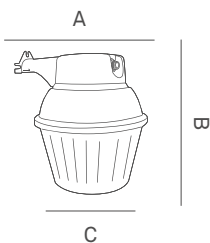

Características

- Cuerpo de policarbonato.
- Difusor prismático de acrílico.
- Montaje de poste o pared.
- Incluye lámparas fluorescentes compactas y fotocelda.

Luminario de seguridad ahorrador a prueba de polvo y goteo

Código	Descripción	W	V	Hz	Dimensiones	Piezas
					AxBxC (mm)	
9401300	Luminario ahorrador	36	127	60	590x130x170	1
9401350	Luminario ahorrador	85	127	60	720x200x270	1

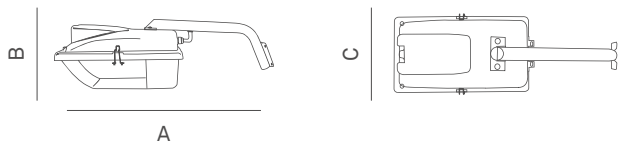

Características

- Cuerpo de policarbonato.
- Reflector de acero inoxidable.
- Difusor de policarbonato transparente.
- Soporte de brazo para empotrar muros o paredes.
- Incluye fotocelda.
- Incluye lámpara fluorescente compacta.

Luminario de seguridad a prueba de polvo y goteo de LED

Código	W	V	Hz	K	lm	Vida (horas)	Piezas
9401800	20	127	60	4 100	2 052	50 000	1



Características

- Cuerpo de policarbonato.
- Reflector de acero inoxidable.
- Difusor de policarbonato transparente.
- Soporte de brazo para empotrar muros o paredes.
- Incluye fotocelda.

Luminario a prueba de polvo y goteo de LED

Código	W	V	Hz	K	lm	Vida (horas)	Piezas
9401830	30	127-240	60	6 500	2 600	50 000	6

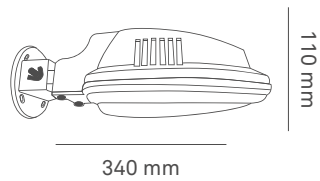

Características

- Cuerpo de policarbonato.
- Difusor de policarbonato transparente.
- Soporte de brazo para empotrar muros o paredes.
- Incluye fotocelda.

Proyectores de LED slim

Código	W	V	Hz	K	lm	Dimensiones	Tipo de LED	Vida	Piezas
						AxBxC (mm)		(horas)	
9403290	10	127-240	60	6 500	800	90x79x26	SMD	30 000	1
9403291	20	127-240	60	6 500	1 600	125x118x26	SMD	30 000	1
9403292	30	127-240	60	6 500	2 400	183x177x26	SMD	30 000	1
9403293	50	127-240	60	6 500	4 000	255x217x28	SMD	30 000	1
9403294	100	127-240	60	6 500	8 000	282x271x29	SMD	30 000	1
9403295	150	127-240	60	6 500	12 000	330x237x37	SMD	30 000	1

9403290

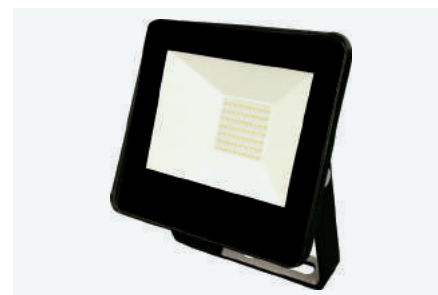
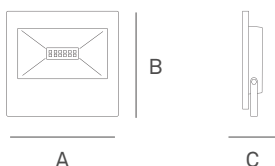
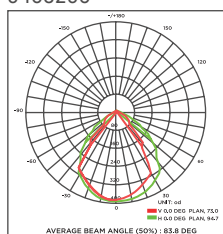

NOM



LED

Lámpara tipo regleta de LED

Código	W	V	Hz	K	lm	Dimensiones	Tipo de LED	Vida	Piezas
						AxB (mm)		(horas)	
9401440	4	100-240	60	6 500	360	307x39	SMD	30 000	1
9401442	4	100-240	60	3 000	360	307x39	SMD	30 000	1
9401445	8	100-240	60	6 500	720	567x39	SMD	30 000	1
9401447	8	100-240	60	3 000	720	567x39	SMD	30 000	1
9401450	12	100-240	60	6 500	1 080	867x39	SMD	30 000	1
9401452	12	100-240	60	3 000	1 080	867x39	SMD	30 000	1
9401455	16	100-240	60	6 500	1 440	1 169x39	SMD	30 000	1
9401457	16	100-240	60	3 000	1 440	1 169x39	SMD	30 000	1

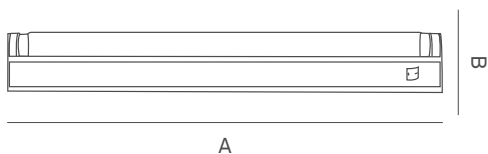

NOM

LED

Luminario reticular para empotrar

Fluorescente

Código	W	V	Hz	K	Base	Ángulo	Piezas
9400953	42	120-277	50/60	4 100	G5	110°	1
9400954	42	120-127	60	4 100	G5	110°	1
9400966	42	120-277	50/60	6 500	G5	110°	1
9400967	42	120-127	60	6 500	G5	110°	1
9400957	84	120-277	50/60	4 100	G5	110°	1
9400968	84	120-277	50/60	6 500	G5	110°	1

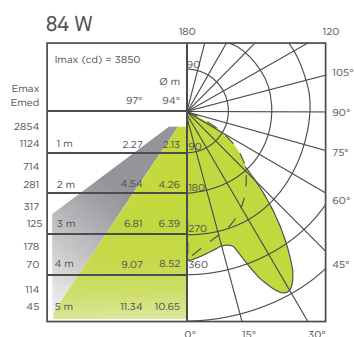
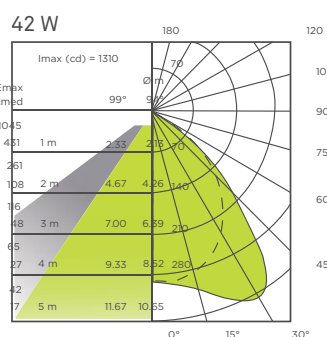

LED

Código	W	V	Hz	K	Base	Ángulo	Im	Vida	Piezas
								(horas)	
9400950LED41	27	110-277	50/60	4 100	G5	110°	2 700	25 000	1
9400950LED65	27	110-277	50/60	6 500	G5	110°	2 700	25 000	1
9400951LED41	54	110-277	50/60	4 100	G5	110°	5 400	25 000	1
9400951LED65	54	110-277	50/60	6 500	G5	110°	5 400	25 000	1

· Incluye driver y lámparas.

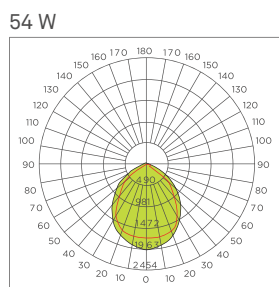
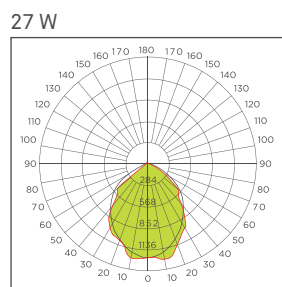

Fluorescente 42 W / LED 27 W

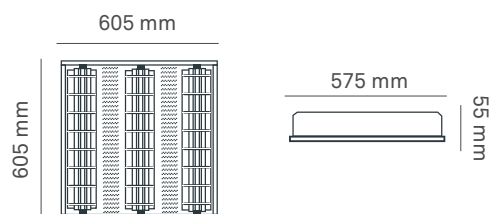

Fluorescente 84 W / LED 54 W

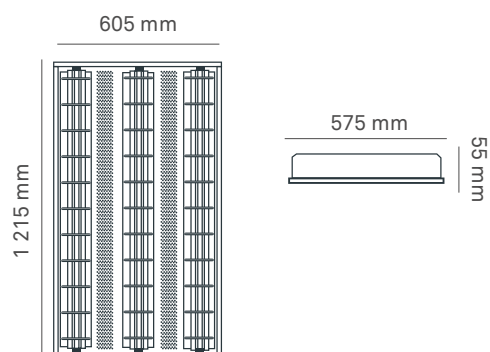

NOTA: Las estructuras de estos luminarios pueden ser adquiridas sin equipo.

Luminario reticular para sobreponer

Fluorescente

Código	W	V	Hz	K	Base	Ángulo	Piezas
9400973	42	120-277	50/60	4 100	G5	110°	1
9400978	42	120-277	60	4 100	G5	110°	1
9400974	42	120-277	50/60	6 500	G5	110°	1
9400979	42	120-277	60	6 500	G5	110°	1
9400976	84	120-277	50/60	4 100	G5	110°	1
9400977	84	120-277	50/60	6 500	G5	110°	1

• Incluye balastro electrónico y lámparas.

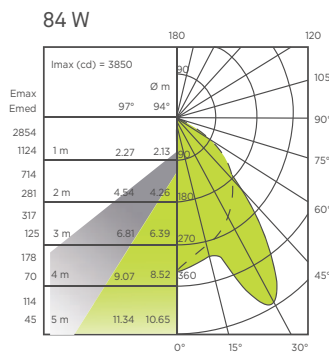
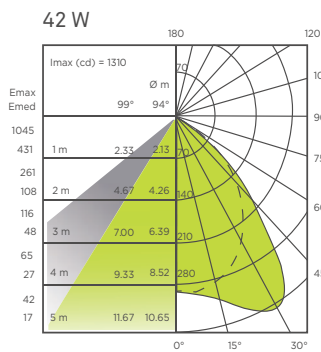

LED

Código	W	V	Hz	K	Base	Ángulo	lm	Vida (horas)	Piezas
9400971LED41	27	110-277	50/60	4 100	G5	110°	2 700	25 000	1
9400971LED65	27	110-277	50/60	6 500	G5	110°	2 700	25 000	1
9400972LED41	54	110-277	50/60	4 100	G5	110°	5 400	25 000	
9400972LED65	54	110-277	50/60	6 500	G5	110°	5 400	25 000	

• Incluye driver y lámparas.

Fluorescente 42 W/LED 27 W

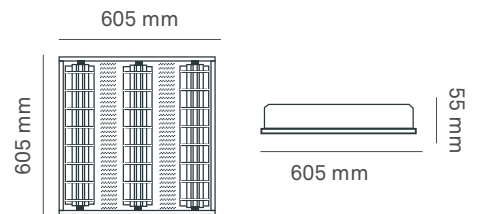

Fluorescente 84 W/ LED 54 W

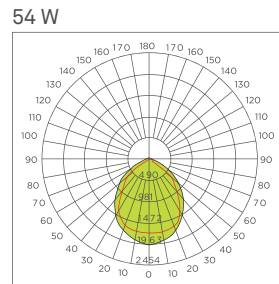
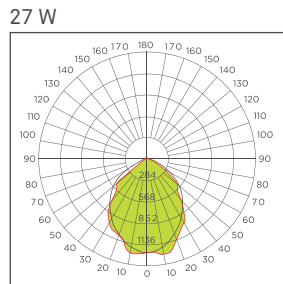
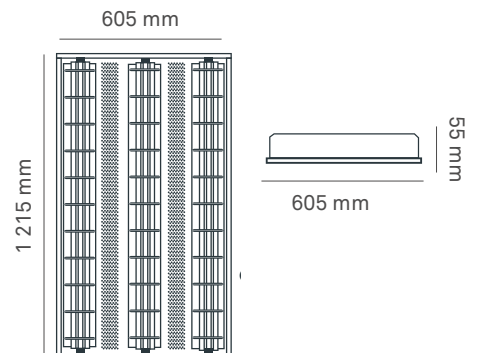

NOTA: Las estructuras de estos luminarios pueden ser adquiridas sin equipo.



Luminario tipo soft-light de empotrar de LED

Código	W	V	Hz	K	Base	Ángulo	lm	Piezas
A1M-4L13A41-F-B3/360	36	120-277	50/60	4 100	T5	90°	3 600	1

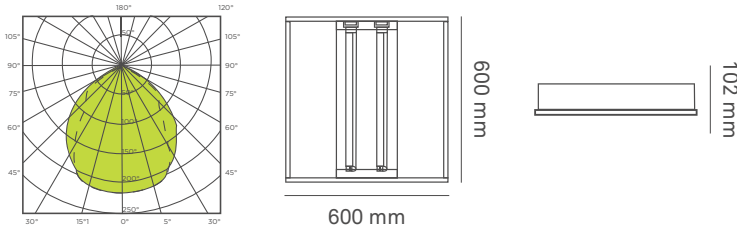

Carcasa

Código	Cuerpo	Terminado	Aplicaciones	Tipo de lámpara	Lámpara incluida	Base	Piezas
A1M-0S13S0-G-B3/00	Aluminio	Blanco	Empotrar en techo	Tubo T5	No	T5	1

Luminario tipo soft-light de empotrar de LED

Código	W	V	Hz	K	Base	Ángulo	lm	Piezas
A1M-4L13A41-F-B4/360	36	120-277	50/60	4 100	T5	90°	3 600	1

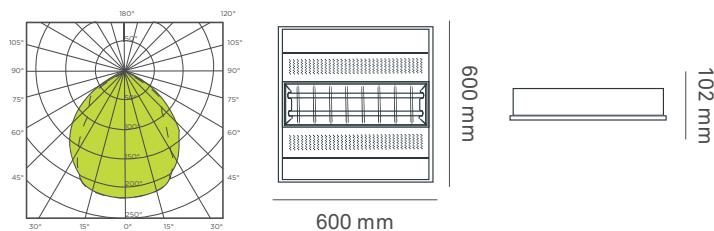

Carcasa

Código	Cuerpo	Terminado	Aplicaciones	Tipo de lámpara	Lámpara incluida	Base	Piezas
A1M-0S13S0-G-B4/00	Aluminio	Blanco	Empotrar en techo	Tubo T5	No	T5	1

Luminario rectangular de suspender de LED con 1 lámpara con difusor acrílico aluminio

Código	W	V	Hz	K	Base	Ángulo	lm	Piezas
A3M-1L13F41-F-G-A6/180	18	100 - 277	50/60	4 100	T5	90°	1 800	1

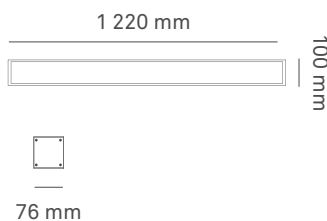
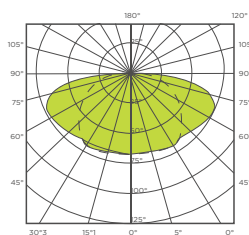

Carcasa

Código	Cuerpo	Terminado	Aplicaciones	Tipo de lámpara	Lámpara incluida	Base	Piezas
A3M-OS13S0-G-A6/00	Aluminio	Satinado	Suspender en techo	Tubo T5	No	T5	1

Luminario rectangular de suspender de LED con 1 lámpara con difusor reticular aluminio

Código	W	V	Hz	K	Base	Ángulo	lm	Piezas
A3M-1L13F41-F-G-A7/180	18	100-277	50/60	4 100	T5	90°	1 800	1

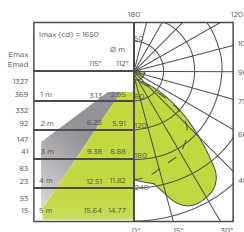

Carcasa

Código	Cuerpo	Terminado	Aplicaciones	Tipo de lámpara	Lámpara incluida	Base	Piezas
A3M-OS13S0-G-A7/00	Aluminio	Satinado	Suspender en techo	Tubo T5	No	T5	1

Luminario rectangular de suspender de LED con 2 lámparas con difusor acrílico aluminio

Código	W	V	Hz	K	Base	Ángulo	lm	Piezas
A3M-2L13F41-F-G-A6/360	36	100-277	50/60	4 100	T5	90°	3 600	1

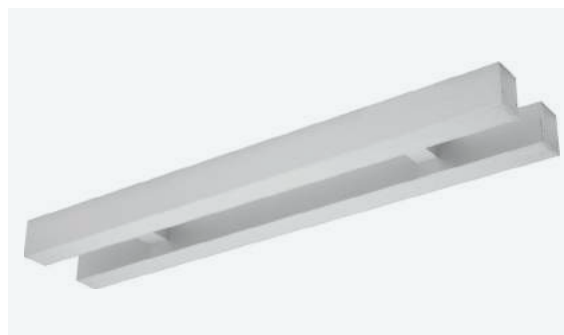
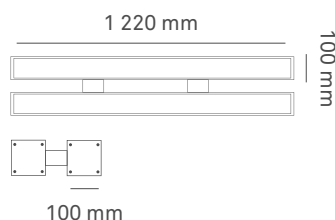
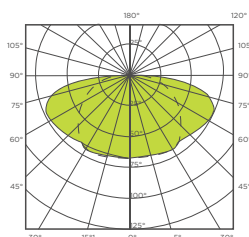

Carcasa

Código	Cuerpo	Terminado	Aplicaciones	Tipo de lámpara	Lámpara incluida	Base	Piezas
A3M-0S13S0-G-A6/01	Aluminio	Satinado	Suspender en techo	Tubo T5	No	T5	1

Luminario ovalado de suspender de LED con 4 lámparas con difusor acrílico aluminio

Código	W	V	Hz	K	Base	Ángulo	lm	Piezas
A3M-4L13F41-F-G-A10/720	72	120-277	50/60	4 100	T5	90°	7 200	1

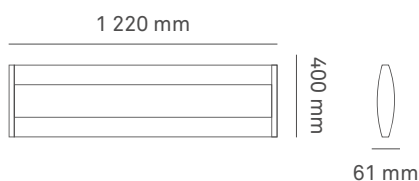
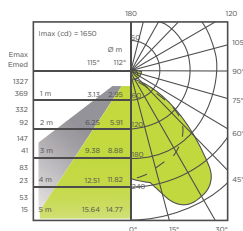

Carcasa

Código	Cuerpo	Terminado	Aplicaciones	Tipo de lámpara	Lámpara incluida	Base	Piezas
A3M-0S13S0-G-A10/02	Aluminio	Satinado	Empotrar en techo	Tubo T5	No	T5	1

Luminario panel de LED tipo C 60x60

Código	W	V	Hz	K	Ángulo	lm	Vida (horas)	Piezas
9403112	40	85-265	60	4 100	120°	4 000	50 000	1
9403113	40	85-265	60	3 000	120°	4 000	50 000	1
9403116	40	85-265	60	6 500	120°	4 000	50 000	1

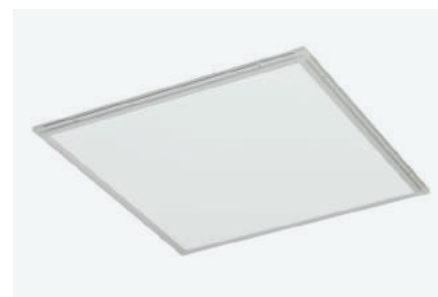
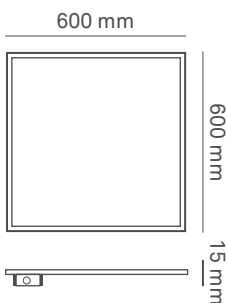
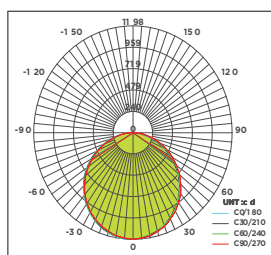

Luminario panel de LED tipo C 120x30

Código	W	V	Hz	K	Ángulo	lm	Vida (horas)	Piezas
9403117	40	85-265	60	4 100	120°	4 000	50 000	1
9403134	40	85-265	60	6 500	120°	4 000	50 000	1

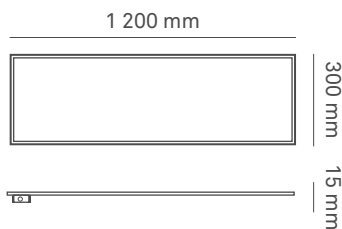
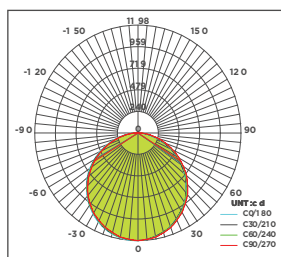

Luminario panel de LED tipo C 120x60

Código	W	V	Hz	K	Ángulo	lm	Vida (horas)	Piezas
9403119	70	85-265	60	4 100	120°	7 000	50 000	1
9403135	70	85-265	60	6 500	120°	7 000	50 000	1

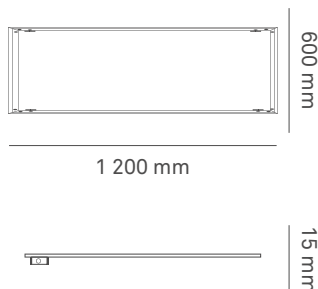
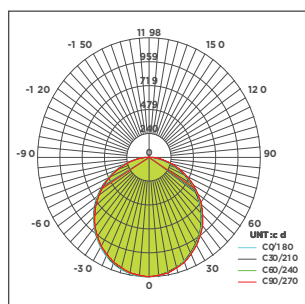

Accesorios para luminarios paneles de LED tipo C

Código	Descripción	Piezas
9403122	Juego de colgadores para suspender panel de LED tipo C 60x60	1
9403127	Juego de colgadores para suspender panel de LED tipo C 120x30	1
9403124	Juego de colgadores para suspender panel 60x60/120x30	1
9403123	Accesorio para sobreponer panel de LED tipo C 60x60	1
9403128	Accesorio para sobreponer panel de LED tipo C 120x30	1
9403131	Marco para sobreponer panel de LED tipo C 60x60	1
9403132	Marco para sobreponer panel de LED tipo C 120x30	1
9403133	Marco para sobreponer panel de LED tipo C 120x60	1

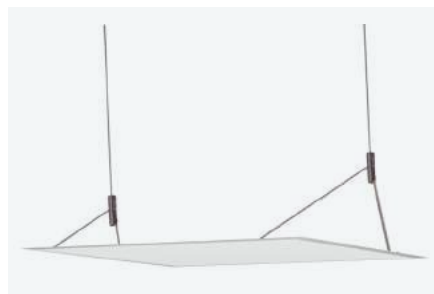

Juego de colgadores para suspender



Accesorio para sobreponer



Marco para sobreponer

Luminario high bay tipo ESQ

Fluorescente

Código	W	V	Hz	K	Base	Ángulo	Piezas
9401721*	112	120-277	50/60	—	G5	100°	1
9401722*	216	120-277	50/60	—	G5	100°	1
9401726*	168	120-277	50/60	—	G5	100°	1
9401727*	324	120-277	50/60	—	G5	100°	1
9401740**	216	120-277	50/60	4 100	G5	100°	1
9401745**	324	120-277	50/60	4 100	G5	100°	1
9401741**	216	120-277	50/60	6 500	G5	100°	1
9401746**	324	120-277	50/60	6 500	G5	100°	1



* No incluye lámparas
** Incluye balastro electrónico y lámparas

LED

Código	W	V	Hz	K	Base	Ángulo	lm	Vida (horas)	Piezas
9401725LED41	112	110-277	60	4 100	G5	100°	14 000	25 000	1
9401725LED65	112	110-277	60	6 500	G5	100°	14 000	25 000	1
9401720LED41	168	110-277	60	4 100	G5	100°	21 000	25 000	1
9401720LED65	168	110-277	60	6 500	G5	100°	21 000	25 000	1



Fluorescente 216 W

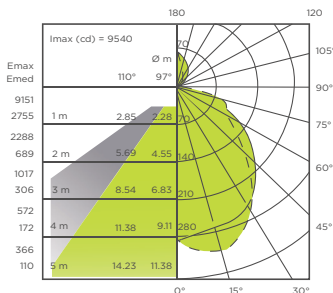

LED 112 W

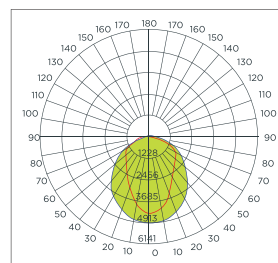

112/216 W

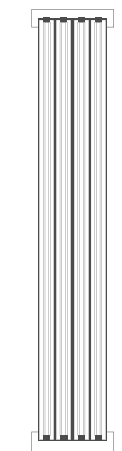

309 mm

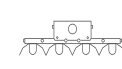

1 220 mm

55 mm

168/324 W

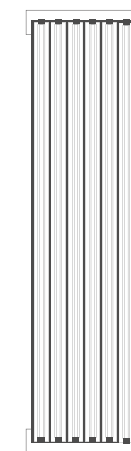

344 mm

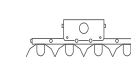

1 220 mm

60 mm

Estructura

Código	Descripción	Tipo de lámpara	Piezas
9401720	Estructura 4x28/54 W	T5	1
9401725	Estructura 6x28/54 W	T5	1

Características

- Cuerpo de lámina de acero.
- Pintura electrostática blanca con protector antioxidante.
- Reflector de aluminio especular.
- Incluye bases.

Luminario high bay tipo gabinete

Fluorescente

Código	W	V	Hz	K	Base	Ángulo	Piezas
9401701*	112	120-277	50/60	—	G5	100°	1
9401702*	216	120-277	50/60	—	G5	100°	1
9401711*	168	120-277	50/60	—	G5	100°	1
9401712*	324	120-277	50/60	—	G5	100°	1
9401730**	216	120-277	50/60	4 100	G5	100°	1
9401735**	324	120-277	50/60	4 100	G5	100°	1
9401731**	216	120-277	50/60	6 500	G5	100°	1
9401736**	324	120-277	50/60	6 500	G5	100°	1



* No incluye lámparas

** Incluye balastro electrónico y lámparas

LED

Código	W	V	Hz	K	Base	Ángulo	lm	Vida	Piezas
								(horas)	
9401700LED41	112	110-277	60	4 100	G5	100°	14 000	25 000	1
9401700LED65	112	110-277	60	6 500	G5	100°	14 000	25 000	1
9401710LED41	168	110-277	60	4 100	G5	100°	21 000	25 000	1
9401710LED65	168	110-277	60	6 500	G5	100°	21 000	25 000	1



Fluorescente 216 W

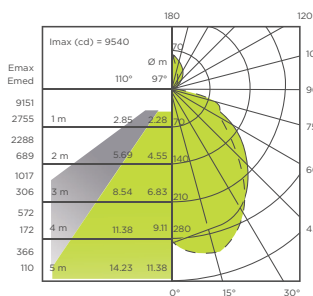

LED 112 W

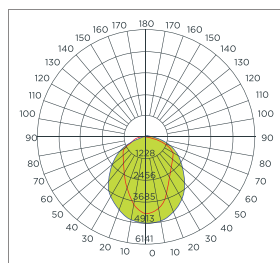

112/216 W



285 mm

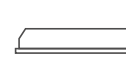

1 220 mm

96 mm

168/324 W

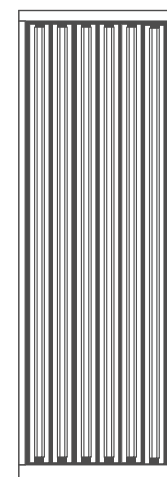

410 mm

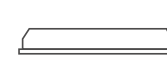

1 220 mm

96 mm

Estructura

Código	Descripción	Tipo de lámpara	Piezas
9401700	Estructura 4x28/54 W	T5	1
9401710	Estructura 6x28/54 W	T5	1

Características

- Cuerpo de lámina de acero.
- Pintura electrostática blanca con protector antioxidante.
- Reflector de aluminio especular.
- Incluye bases.

Luminario high bay de LED

Código	W	V	Hz	K	Ángulo	lm	Vida	Piezas
							(horas)	
9401750	100	90-305	50 / 60	5 000	120°	13 000	35 000	1
9401755	200	90-305	50 / 60	5 000	120°	26 000	35 000	1



Características

- Cuerpo de lámina de acero.
- Pintura electrostática blanca con protector antioxidante.
- Reflector de aluminio especular.
- Incluye bases.
- Cuenta con certificación UL

9401750

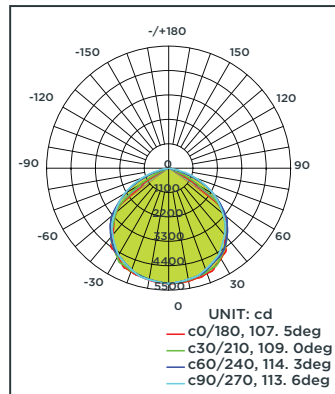

9401755

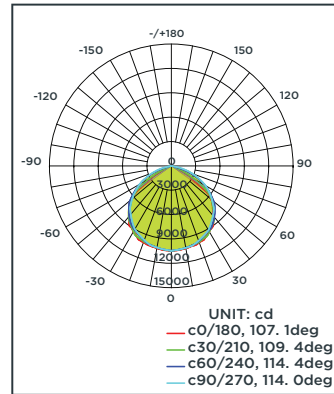

9401750

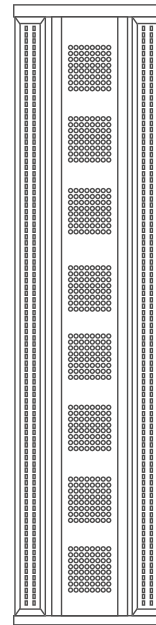

1 094 mm

9401755

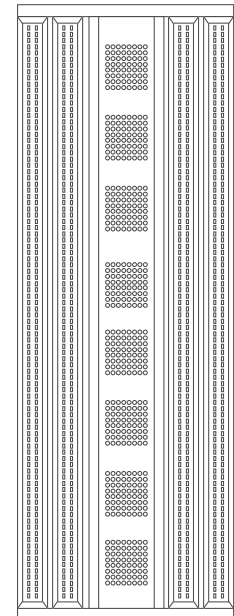

1 094 mm

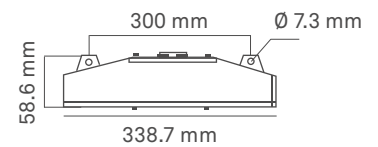
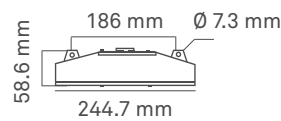

Luminario circular high bay de LED

Código	W	V	Hz	K	Ángulo	lm	Vida (horas)	Piezas
9401780	150	90-305	60	5 000	120°	19 000	50 000	1
9401785	200	90-305	60	5 000	120°	26 000	50 000	1

· Cuenta con certificación UL

9401780

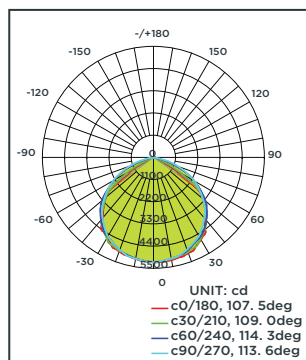

9401785

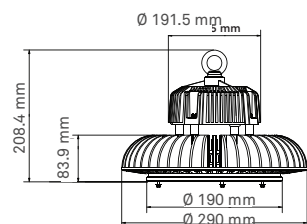
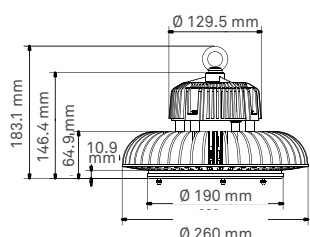
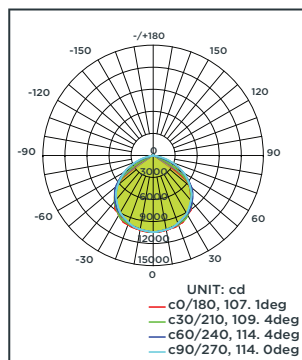

Campana de aluminio para luminario circular high bay

Código	Descripción	Piezas
CAM60AL	Campana de aluminio 60°	1
CAM90AL	Campana de aluminio 90°	1
CAM70PC	Campana de aluminio 70°	1



Soporte para luminario circular high bay

Código	Descripción	Piezas
9401786	Soporte para campana de LED	1



Estructura a prueba de polvo y goteo

Código	Descripción	Dimensiones	Piezas
		AxBxCxD (mm)	
9400504	Estructura 1x17 W	662x350x1111x95	1
9400505	Estructura 1x14 W	662x350 x111x95	1
9400506	Estructura 2x17 W	662x350x1111x145	1
9400507	Estructura 2x14 W	662x350x111x145	1
9400515	Estructura 1x32 W	1 272x700x1111x95	1
9400517	Estructura 1x28/54 W	1 272x700x1111x95	1
9400510	Estructura 2x32 W	1 272x700x111x145	1
9400512	Estructura 2x28/54 W	1 272x700x111x145	1



Características

- Cuerpo de policarbonato color gris RAL7035.
- Difusor de policarbonato transparente.
- Empaque de poliuretano expandido.
- Reflector de lámina de acero pintado electrostáticamente en blanco.
- Juego de herrajes para montaje suspendido o sobreponer en el techo.

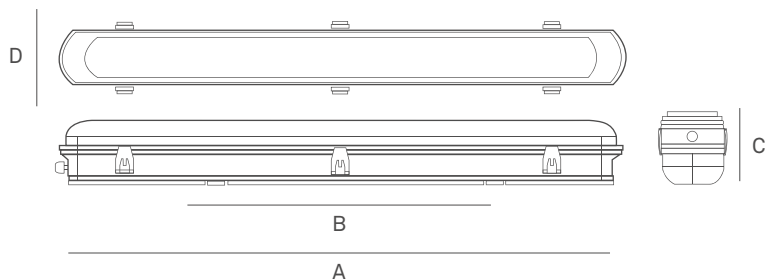



Luminario a prueba de polvo y goteo T8

Código	Descripción	V	Hz	K	Base	Tipo de lámpara	Ángulo	Piezas
9400504A*	1x17 W	120-277	50/60	—	G13	T8	80°	1
9400504B*	1x17 W	120-127	60	—	G13	T8	80°	1
9400506A*	2x17 W	120-277	50/60	—	G13	T8	80°	1
9400506B*	2x17 W	120-127	60	—	G13	T8	80°	1
9400504BT41**	1x17 W	120-127	60	4 100	G13	T8	80°	1
9400504AT41**	1x17 W	120-277	50/60	4 100	G13	T8	80°	1
9400504BT65**	1x17 W	120-127	60	6 500	G13	T8	80°	1
9400504AT65**	1x17 W	120-277	50/60	6 500	G13	T8	80°	1
9400506BT41**	2x17 W	120-127	60	4 100	G13	T8	80°	1
9400506AT41**	2x17 W	120-277	50/60	4 100	G13	T8	80°	1
9400506BT65**	2x17 W	120-127	60	6 500	G13	T8	80°	1
9400506AT65**	2x17 W	120-277	50/60	6 500	G13	T8	80°	1
9400515B*	1x32 W	120-127	60	—	G13	T8	80°	1
9400515A*	1x32 W	120-277	50/60	—	G13	T8	80°	1
9400510B*	2x32 W	120-127	60	—	G13	T8	80°	1
9400510A*	2x32 W	120-277	50/60	—	G13	T8	80°	1
9400515BT41**	1x32 W	120-127	60	4 100	G13	T8	80°	1
9400515BT65**	1x32 W	120-127	60	6 500	G13	T8	80°	1
9400515AT41**	1x32 W	120-277	50/60	4 100	G13	T8	80°	1
9400515AT65**	1x32 W	120-277	50/60	6 500	G13	T8	80°	1
9400510BT41**	2x32 W	120-127	60	4 100	G13	T8	80°	1
9400510BT65**	2x32 W	120-127	60	6 500	G13	T8	80°	1
9400510AT41**	2x32 W	120-277	50/60	4 100	G13	T8	80°	1
9400510AT65**	2x32 W	120-277	50/60	6 500	G13	T8	80°	1

* No incluye lámparas

** Incluye balastro electrónico y lámparas



Powered by
PHILIPS



Luminario a prueba de polvo y goteo T5

Código	Descripción	V	Hz	K	Base	Tipo de lámpara	Ángulo	Piezas
9400505P*	1x14 W	120-277	50/60	—	G5	T5	80°	1
94005007P*	2x14 W	120-277	50/60	—	G5	T5	80°	1
9400505PT41**	1x14 W	120-277	50/60	4 100	G5	T5	80°	1
9400505PT65**	1x14 W	120-277	50/60	6 500	G5	T5	80°	1
9400507PT41**	2x14 W	120-277	50/60	4 100	G5	T5	80°	1
9400507PT65**	2x14 W	120-277	50/60	6 500	G5	T5	80°	1
9400515P*	1 x28 W	120-277	50/60	—	G5	T5	80°	1
9400525P*	1x54 W	120-277	50/60	—	G5	T5	80°	1
9400510P*	2x28 W	120-277	50/60	—	G5	T5	80°	1
9400520P*	2x54 W	120-277	50/60	—	G5	T5	80°	1
9400515PT41**	1x28 W	120-277	50/60	4 100	G5	T5	80°	1
9400515PT65**	1x28 W	120-277	50/60	6 500	G5	T5	80°	1
9400525PT41**	1x54 W	120-277	50/60	4 100	G5	T5	80°	1
9400525PT65**	1x54 W	120-277	50/60	6 500	G5	T5	80°	1
9400510PT41**	2x28 W	120-277	50/60	4 100	G5	T5	80°	1
9400510PT65**	2x28 W	120-277	50/60	6 500	G5	T5	80°	1
9400520PT41**	2x54 W	120-277	50/60	4 100	G5	T5	80°	1
9400520PT65**	2x54 W	120-277	50/60	6 500	G5	T5	80°	1

* No incluye lámparas

** Incluye balastro electrónico y lámparas



Powered by
PHILIPS



Luminario a prueba de polvo y goteo con tubos de LED Philips

Código	W	V	Hz	K	lm	Vida (horas)	Piezas
9400509LED41	36	100-240	50/60	4 100	3 600	30 000	1
9400509LED65	36	100-240	50/60	6 500	3 600	30 000	1

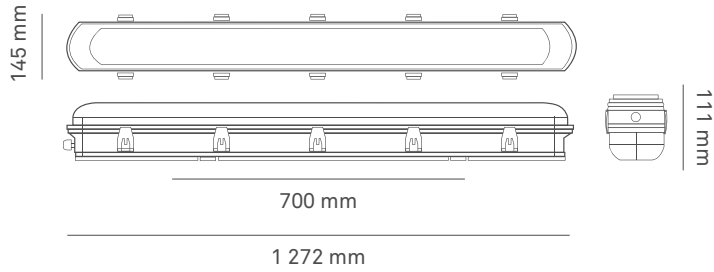

Luminario a prueba de polvo y goteo con tubos de LED Argos

Código	W	V	Hz	K	lm	Vida (horas)	Piezas
9400511LED41	36	100-277	50/60	4 100	3 600	30 000	1
9400511LED65	36	100-277	50/60	6 500	3 600	30 000	1

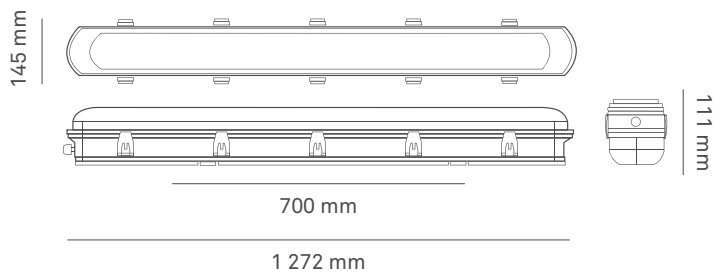

Luminario a prueba de polvo y goteo de LED

Código	W	V	Hz	K	lm	Vida (horas)	Piezas
9400545LED41	36	120-277	50/60	4 100	4 680	30 000	1

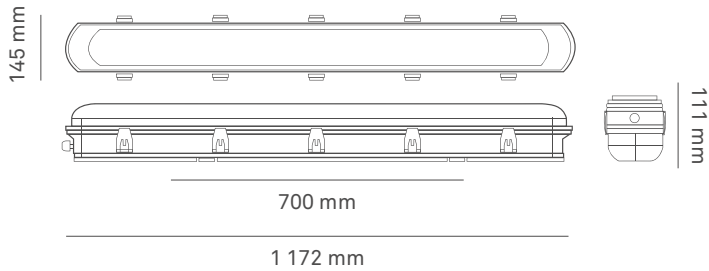

Luminario a prueba de polvo y goteo de LED con disipador de calor

Código	W	V	Hz	K	lm	Vida (horas)	Piezas
9400540LED41	36	120-277	50/60	4 100	4 680	30 000	1

· Incluye disipador de calor.

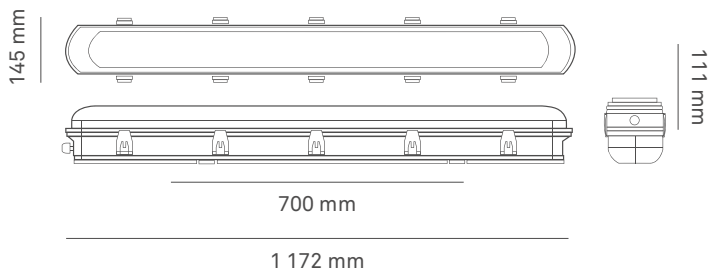



Kit de suspensión

Código	Descripción	Piezas
9403140	Kit de suspensión para luminario a prueba de polvo y goteo	1

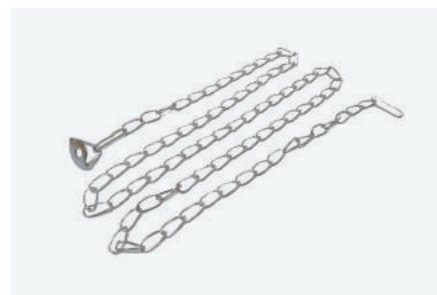

Difusores

Código	Descripción	Piezas
9400560	Difusor de policarbonato 1x14/17 W	1
9400561	Difusor de policarbonato 1x28/32 W	1
9400562	Difusor de policarbonato 2x14/17 W	1
9400563	Difusor de policarbonato 2x28/32 W	1



Juego de herrajes

Código	Descripción	Piezas
9400564	Juego de herrajes APG 14-17 W	1
9400565	Juego de herrajes APG 28-327 W	1



Estructura tipo urbano

Código	Descripción	W	Piezas
9402250	Carcasa para luminario tipo urbano	250	2

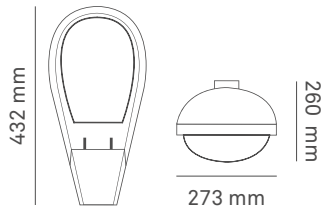

Refacciones

Código	Descripción	Piezas
9402251	Cristal para luminario industrial OV250	8

Luminario tipo urbano de LED

Código	W	V	Hz	K	Dimensiones	lm	Tipo de LED	Vida	Piezas
					AxBxC (mm)				
9402282	50	90-305	60	6 000	650x236x120	4 500	NICHIA	50 000	1
9402284	100	90-305	60	6 000	810x280x120	9 000	NICHIA	50 000	1
9402286	150	90-305	60	6 000	810x280x120	13 500	NICHIA	50 000	1

· Incluyen fotocelda

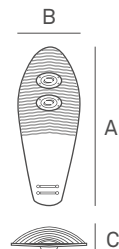
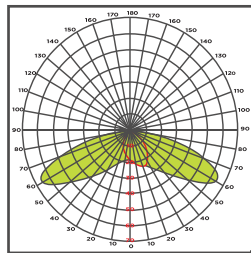

Luminario wall pack de LED alto brillo

Código	W	V	Hz	K	lm	Tipo de LED	Vida (horas)	Piezas
ARLED107	40	100-277	60	5 000	4 800	NICHIA	50 000	1

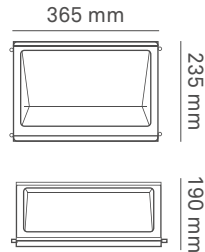
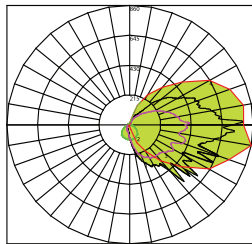

Luminario cuadrado wall pack de LED alto brillo

Código	W	V	Hz	K	lm	Tipo de LED	Vida (horas)	Piezas
ARLED302	40	100-277	60	4 700	5 000	NICHIA	50 000	1

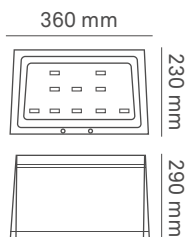
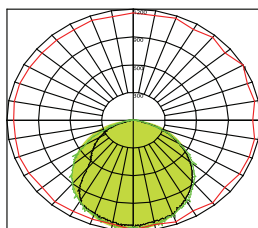

Luminario tipo estacionamiento de LED

Código	W	V	Hz	K	lm	Tipo de LED	Vida (horas)	Piezas
ARLED365	40	100-277	60	5 000	4 900	NICHIA	50 000	1

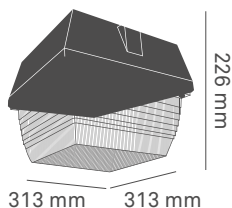
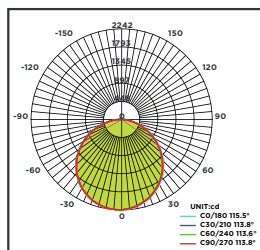

Lámparas de emergencia 3.6 V

Código	Descripción	W	V	Hz	Duración (minutos)	Piezas
9401575	Lámpara de emergencia 3.6 V- LED	4	127	60	90	1

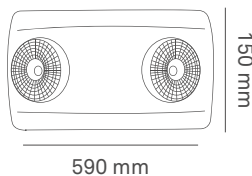

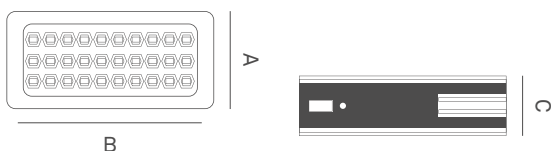

Lámparas de emergencia

Código	Descripción	V	Hz	Dimensiones	Duración	Piezas
				AxBxC (mm)	(minutos)	
9401515	Lámpara de emergencia 30 LEDs	127	60	64x220x45	90	1
9401520	Lámpara de emergencia 60 LEDs	127	60	60x393x43	60	1
9401580	Lámpara de emergencia 90 LEDs	127	60	79x625x70	60	1



Lámparas de señalización

Código	Color	Descripción	V	Hz	Duración	Piezas
					(minutos)	
9401591		“Salida” color verde	127	60	1 200	1
9401592		“Salida” color rojo	127	60	1 200	1

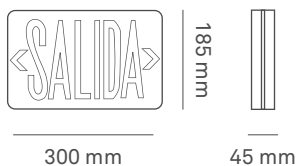

Portalámpara tipo candil

Código	Material	W	Base	Piezas
9400120	Cerámica	660	E-12	50
9400125	Cerámica	660	E-14	50

NOM



Portalámpara tipo anuncio

Código	Material	W	Base	Piezas
9400130	Cerámica	660	E-26	240

NOM



Portalámpara base cuadrada

Código	Material	W	Base	Piezas
9400160	Cerámica	660	E-26	240

NOM





Portalámpara redonda 4"

Código	Material	W	Base	Piezas
9400140	Baquelita	660	E-26	240
9400150	Cerámica	660	E-26	50

NOM



Portalámpara tipo mogul

Código	Material	W	Base	Piezas
9400170	Cerámica	660	E-40	50

· Incluye cables para instalación.

NOM



Adaptador con portalámparas fluorescente

Código	W	Tubo	Piezas
9400998	660	T-5	100

NOM



Portalámparas fluorescente

Código	W	Tubo	Piezas
9400992	660	T-5	100
9400995	660	T-8	200

NOM



Portalámpara GU10

Código	W	Base	Piezas
9400110	50	GU10	50

· Incluye cables para instalación.

NOM



Portalámparas con sensor de movimiento

Código	Descripción	V	Hz	Base	Piezas
9402520	Portalámparas con sensor de movimiento	127	60	E-26	1

NOM





Sensor de movimiento

Código	Descripción	W	V	Hz	Piezas
9402510	Sensor de movimiento de techo	36	127	60	1
9402500	Sensor de movimiento de pared	85	127	60	1

NOM

Fotocelda

Código	Descripción	V	Piezas
9402300	Interruptor fotoeléctrico	120-240	100

NOM

Base para fotocelda

Código	Descripción	V	Piezas
9402400	Base para fotocelda con ménsula	120-240	100

NOM

Interruptor fotoeléctrico

Código	Descripción	V	Piezas
9402360	Interruptor fotoeléctrico	127	100

NOM



Transformador electrónico de bajo voltaje para lámpara halógena

Código	Descripción	Piezas
9403400	Transformador 127 V a 12 V, 50 W máx.	50



Conectores IP-68

Código	Descripción	V	A	Piezas
9401010	Conector en "T"	450	24	50
9401020	Conector en "Línea"	450	24	50





Kit de iluminación metálico

Código	Descripción	V	A	Clavija	Contacto	Piezas
8890010	Kit metálico de 1 m en cada lado	125	15	8830525	8810505	1
8890020	Kit metálico de 1 m en cada lado	277	8830530	8810515	1	
8890030	Kit metálico de 30 cm en clavija	125	15	8830525	8810505	1
8890040	Kit metálico de 30 cm en clavija	277	15	8830530	8810515	1

· Contiene 3 conductores 14 AWG de 15 A

NOM



Kit de iluminación uso rudo

Código	Descripción	V	A	Clavija	Contacto	Piezas
8890110	Kit uso rudo de 1 m en cada lado	125	15	8830525	8810505	1
8890120	Kit uso rudo de 1 m en cada lado	277	15	8830530	8810515	1
8890130	Kit uso rudo de 30 cm en clavija	125	15	8830525	8810505	1
8890140	Kit uso rudo de 30 cm en clavija	277	15	8830530	8810515	1
8890150	Kit uso rudo de 5 m en clavija	125	15	8830525	8810505	1
8890160	Kit uso rudo de 5 m en clavija	277	15	8830530	8810515	1

· Contiene 3 conductores 14 AWG de 15 A

NOM

